

# R&S<sup>®</sup> ZN-Z85 Switch Matrix User Manual



1326.4819.02 – 02

This manual describes the R&S®ZN-Z85 Base Unit and port extension option:

- Variant **02**

- R&S®ZN-Z85 "Matrix Base Unit 2x6, SMA (f), 10 MHz to 20 GHz", order no. 1326.4777.**02**
- R&S®ZN-Z85-B24 "Additional Test Ports 7-12, 4 VNA Ports", order no. 1326.4831.**24**

- Variant **03**

- R&S®ZN-Z85 "Matrix Base Unit 2x6, SMA (f), 10 MHz to 20 GHz", order no. 1326.4777.**03**
- R&S®ZN-Z85-B24 "Additional Test Ports 7-12, 4 VNA Ports", order no. 1326.4831.**26**

The software contained in this product makes use of several valuable open source software packages. For information, see the "Open Source Acknowledgment" on the user documentation CD-ROM (included in delivery).

Rohde & Schwarz would like to thank the open source community for their valuable contribution to embedded computing.

© 2015 Rohde & Schwarz GmbH & Co. KG

Mühlendorfstr. 15, 81671 München, Germany

Phone: +49 89 41 29 - 0

Fax: +49 89 41 29 12 164

Email: [info@rohde-schwarz.com](mailto:info@rohde-schwarz.com)

Internet: [www.rohde-schwarz.com](http://www.rohde-schwarz.com)

Subject to change – Data without tolerance limits is not binding.

R&S® is a registered trademark of Rohde & Schwarz GmbH & Co. KG.

Trade names are trademarks of the owners.

Throughout this manual: R&S® is abbreviated as R&S

# Basic Safety Instructions

## Always read through and comply with the following safety instructions!

All plants and locations of the Rohde & Schwarz group of companies make every effort to keep the safety standards of our products up to date and to offer our customers the highest possible degree of safety. Our products and the auxiliary equipment they require are designed, built and tested in accordance with the safety standards that apply in each case. Compliance with these standards is continuously monitored by our quality assurance system. The product described here has been designed, built and tested in accordance with the EC Certificate of Conformity and has left the manufacturer's plant in a condition fully complying with safety standards. To maintain this condition and to ensure safe operation, you must observe all instructions and warnings provided in this manual. If you have any questions regarding these safety instructions, the Rohde & Schwarz group of companies will be happy to answer them.

Furthermore, it is your responsibility to use the product in an appropriate manner. This product is designed for use solely in industrial and laboratory environments or, if expressly permitted, also in the field and must not be used in any way that may cause personal injury or property damage. You are responsible if the product is used for any purpose other than its designated purpose or in disregard of the manufacturer's instructions. The manufacturer shall assume no responsibility for such use of the product.

The product is used for its designated purpose if it is used in accordance with its product documentation and within its performance limits (see data sheet, documentation, the following safety instructions). Using the product requires technical skills and, in some cases, a basic knowledge of English. It is therefore essential that only skilled and specialized staff or thoroughly trained personnel with the required skills be allowed to use the product. If personal safety gear is required for using Rohde & Schwarz products, this will be indicated at the appropriate place in the product documentation. Keep the basic safety instructions and the product documentation in a safe place and pass them on to the subsequent users.











Observing the safety instructions will help prevent personal injury or damage of any kind caused by dangerous situations. Therefore, carefully read through and adhere to the following safety instructions before and when using the product. It is also absolutely essential to observe the additional safety instructions on personal safety, for example, that appear in relevant parts of the product documentation. In these safety instructions, the word "product" refers to all merchandise sold and distributed by the Rohde & Schwarz group of companies, including instruments, systems and all accessories. For product-specific information, see the data sheet and the product documentation.

## Safety labels on products

The following safety labels are used on products to warn against risks and dangers.

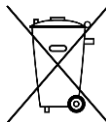
Symbol	Meaning	Symbol	Meaning
	Notice, general danger location Observe product documentation		ON/OFF Power
	Caution when handling heavy equipment		Standby indication
	Danger of electric shock		Direct current (DC)

## Basic Safety Instructions

Symbol	Meaning	Symbol	Meaning
	Caution ! Hot surface		Alternating current (AC)
	Protective conductor terminal To identify any terminal which is intended for connection to an external conductor for protection against electric shock in case of a fault, or the terminal of a protective earth		Direct/alternating current (DC/AC)
	Earth (Ground)		Class II Equipment to identify equipment meeting the safety requirements specified for Class II equipment (device protected by double or reinforced insulation)
	Frame or chassis Ground terminal		EU labeling for batteries and accumulators For additional information, see section "Waste disposal/Environmental protection", item 1.
	Be careful when handling electrostatic sensitive devices		EU labeling for separate collection of electrical and electronic devices For additional information, see section "Waste disposal/Environmental protection", item 2.
	Warning! Laser radiation For additional information, see section "Operation", item 7.		

### Signal words and their meaning

The following signal words are used in the product documentation in order to warn the reader about risks and dangers.



Indicates a hazardous situation which, if not avoided, will result in death or serious injury.



Indicates a hazardous situation which, if not avoided, could result in death or serious injury.



Indicates a hazardous situation which, if not avoided, could result in minor or moderate injury.



Indicates information considered important, but not hazard-related, e.g. messages relating to property damage.

In the product documentation, the word ATTENTION is used synonymously.

These signal words are in accordance with the standard definition for civil applications in the European Economic Area. Definitions that deviate from the standard definition may also exist in other economic areas or military applications. It is therefore essential to make sure that the signal words described here are always used only in connection with the related product documentation and the related product. The use of signal words in connection with unrelated products or documentation can result in misinterpretation and in personal injury or material damage.

## Basic Safety Instructions

### Operating states and operating positions

*The product may be operated only under the operating conditions and in the positions specified by the manufacturer, without the product's ventilation being obstructed. If the manufacturer's specifications are not observed, this can result in electric shock, fire and/or serious personal injury or death. Applicable local or national safety regulations and rules for the prevention of accidents must be observed in all work performed.*

1. Unless otherwise specified, the following requirements apply to Rohde & Schwarz products: predefined operating position is always with the housing floor facing down, IP protection 2X, use only indoors, max. operating altitude 2000 m above sea level, max. transport altitude 4500 m above sea level. A tolerance of  $\pm 10\%$  shall apply to the nominal voltage and  $\pm 5\%$  to the nominal frequency, overvoltage category 2, pollution degree 2.
2. Do not place the product on surfaces, vehicles, cabinets or tables that for reasons of weight or stability are unsuitable for this purpose. Always follow the manufacturer's installation instructions when installing the product and fastening it to objects or structures (e.g. walls and shelves). An installation that is not carried out as described in the product documentation could result in personal injury or even death.
3. Do not place the product on heat-generating devices such as radiators or fan heaters. The ambient temperature must not exceed the maximum temperature specified in the product documentation or in the data sheet. Product overheating can cause electric shock, fire and/or serious personal injury or even death.

### Electrical safety

*If the information on electrical safety is not observed either at all or to the extent necessary, electric shock, fire and/or serious personal injury or death may occur.*

1. Prior to switching on the product, always ensure that the nominal voltage setting on the product matches the nominal voltage of the mains-supply network. If a different voltage is to be set, the power fuse of the product may have to be changed accordingly.
2. In the case of products of safety class I with movable power cord and connector, operation is permitted only on sockets with a protective conductor contact and protective conductor.
3. Intentionally breaking the protective conductor either in the feed line or in the product itself is not permitted. Doing so can result in the danger of an electric shock from the product. If extension cords or connector strips are implemented, they must be checked on a regular basis to ensure that they are safe to use.
4. If there is no power switch for disconnecting the product from the mains, or if the power switch is not suitable for this purpose, use the plug of the connecting cable to disconnect the product from the mains. In such cases, always ensure that the power plug is easily reachable and accessible at all times. For example, if the power plug is the disconnecting device, the length of the connecting cable must not exceed 3 m. Functional or electronic switches are not suitable for providing disconnection from the AC supply network. If products without power switches are integrated into racks or systems, the disconnecting device must be provided at the system level.
5. Never use the product if the power cable is damaged. Check the power cables on a regular basis to ensure that they are in proper operating condition. By taking appropriate safety measures and carefully laying the power cable, ensure that the cable cannot be damaged and that no one can be hurt by, for example, tripping over the cable or suffering an electric shock.

## Basic Safety Instructions

6. The product may be operated only from TN/TT supply networks fuse-protected with max. 16 A (higher fuse only after consulting with the Rohde & Schwarz group of companies).
7. Do not insert the plug into sockets that are dusty or dirty. Insert the plug firmly and all the way into the socket provided for this purpose. Otherwise, sparks that result in fire and/or injuries may occur.
8. Do not overload any sockets, extension cords or connector strips; doing so can cause fire or electric shocks.
9. For measurements in circuits with voltages  $V_{rms} > 30$  V, suitable measures (e.g. appropriate measuring equipment, fuse protection, current limiting, electrical separation, insulation) should be taken to avoid any hazards.
10. Ensure that the connections with information technology equipment, e.g. PCs or other industrial computers, comply with the IEC 60950-1 / EN 60950-1 or IEC 61010-1 / EN 61010-1 standards that apply in each case.
11. Unless expressly permitted, never remove the cover or any part of the housing while the product is in operation. Doing so will expose circuits and components and can lead to injuries, fire or damage to the product.
12. If a product is to be permanently installed, the connection between the protective conductor terminal on site and the product's protective conductor must be made first before any other connection is made. The product may be installed and connected only by a licensed electrician.
13. For permanently installed equipment without built-in fuses, circuit breakers or similar protective devices, the supply circuit must be fuse-protected in such a way that anyone who has access to the product, as well as the product itself, is adequately protected from injury or damage.
14. Use suitable overvoltage protection to ensure that no overvoltage (such as that caused by a bolt of lightning) can reach the product. Otherwise, the person operating the product will be exposed to the danger of an electric shock.
15. Any object that is not designed to be placed in the openings of the housing must not be used for this purpose. Doing so can cause short circuits inside the product and/or electric shocks, fire or injuries.
16. Unless specified otherwise, products are not liquid-proof (see also section "Operating states and operating positions", item 1). Therefore, the equipment must be protected against penetration by liquids. If the necessary precautions are not taken, the user may suffer electric shock or the product itself may be damaged, which can also lead to personal injury.
17. Never use the product under conditions in which condensation has formed or can form in or on the product, e.g. if the product has been moved from a cold to a warm environment. Penetration by water increases the risk of electric shock.
18. Prior to cleaning the product, disconnect it completely from the power supply (e.g. AC supply network or battery). Use a soft, non-linting cloth to clean the product. Never use chemical cleaning agents such as alcohol, acetone or diluents for cellulose lacquers.

## Operation

1. Operating the products requires special training and intense concentration. Make sure that persons who use the products are physically, mentally and emotionally fit enough to do so; otherwise, injuries or material damage may occur. It is the responsibility of the employer/operator to select suitable personnel for operating the products.

## Basic Safety Instructions

2. Before you move or transport the product, read and observe the section titled "Transport".
3. As with all industrially manufactured goods, the use of substances that induce an allergic reaction (allergens) such as nickel cannot be generally excluded. If you develop an allergic reaction (such as a skin rash, frequent sneezing, red eyes or respiratory difficulties) when using a Rohde & Schwarz product, consult a physician immediately to determine the cause and to prevent health problems or stress.
4. Before you start processing the product mechanically and/or thermally, or before you take it apart, be sure to read and pay special attention to the section titled "Waste disposal/Environmental protection", item 1.
5. Depending on the function, certain products such as RF radio equipment can produce an elevated level of electromagnetic radiation. Considering that unborn babies require increased protection, pregnant women must be protected by appropriate measures. Persons with pacemakers may also be exposed to risks from electromagnetic radiation. The employer/operator must evaluate workplaces where there is a special risk of exposure to radiation and, if necessary, take measures to avert the potential danger.
6. Should a fire occur, the product may release hazardous substances (gases, fluids, etc.) that can cause health problems. Therefore, suitable measures must be taken, e.g. protective masks and protective clothing must be worn.
7. Laser products are given warning labels that are standardized according to their laser class. Lasers can cause biological harm due to the properties of their radiation and due to their extremely concentrated electromagnetic power. If a laser product (e.g. a CD/DVD drive) is integrated into a Rohde & Schwarz product, absolutely no other settings or functions may be used as described in the product documentation. The objective is to prevent personal injury (e.g. due to laser beams).
8. EMC classes (in line with EN 55011/CISPR 11, and analogously with EN 55022/CISPR 22, EN 55032/CISPR 32)
  - Class A equipment:  
Equipment suitable for use in all environments except residential environments and environments that are directly connected to a low-voltage supply network that supplies residential buildings  
Note: Class A equipment is intended for use in an industrial environment. This equipment may cause radio disturbances in residential environments, due to possible conducted as well as radiated disturbances. In this case, the operator may be required to take appropriate measures to eliminate these disturbances.
  - Class B equipment:  
Equipment suitable for use in residential environments and environments that are directly connected to a low-voltage supply network that supplies residential buildings

### Repair and service

1. The product may be opened only by authorized, specially trained personnel. Before any work is performed on the product or before the product is opened, it must be disconnected from the AC supply network. Otherwise, personnel will be exposed to the risk of an electric shock.

## Basic Safety Instructions

- Adjustments, replacement of parts, maintenance and repair may be performed only by electrical experts authorized by Rohde & Schwarz. Only original parts may be used for replacing parts relevant to safety (e.g. power switches, power transformers, fuses). A safety test must always be performed after parts relevant to safety have been replaced (visual inspection, protective conductor test, insulation resistance measurement, leakage current measurement, functional test). This helps ensure the continued safety of the product.

### Batteries and rechargeable batteries/cells

*If the information regarding batteries and rechargeable batteries/cells is not observed either at all or to the extent necessary, product users may be exposed to the risk of explosions, fire and/or serious personal injury, and, in some cases, death. Batteries and rechargeable batteries with alkaline electrolytes (e.g. lithium cells) must be handled in accordance with the EN 62133 standard.*

- Cells must not be taken apart or crushed.
- Cells or batteries must not be exposed to heat or fire. Storage in direct sunlight must be avoided. Keep cells and batteries clean and dry. Clean soiled connectors using a dry, clean cloth.
- Cells or batteries must not be short-circuited. Cells or batteries must not be stored in a box or in a drawer where they can short-circuit each other, or where they can be short-circuited by other conductive materials. Cells and batteries must not be removed from their original packaging until they are ready to be used.
- Cells and batteries must not be exposed to any mechanical shocks that are stronger than permitted.
- If a cell develops a leak, the fluid must not be allowed to come into contact with the skin or eyes. If contact occurs, wash the affected area with plenty of water and seek medical aid.
- Improperly replacing or charging cells or batteries that contain alkaline electrolytes (e.g. lithium cells) can cause explosions. Replace cells or batteries only with the matching Rohde & Schwarz type (see parts list) in order to ensure the safety of the product.
- Cells and batteries must be recycled and kept separate from residual waste. Rechargeable batteries and normal batteries that contain lead, mercury or cadmium are hazardous waste. Observe the national regulations regarding waste disposal and recycling.

### Transport

- The product may be very heavy. Therefore, the product must be handled with care. In some cases, the user may require a suitable means of lifting or moving the product (e.g. with a lift-truck) to avoid back or other physical injuries.
- Handles on the products are designed exclusively to enable personnel to transport the product. It is therefore not permissible to use handles to fasten the product to or on transport equipment such as cranes, fork lifts, wagons, etc. The user is responsible for securely fastening the products to or on the means of transport or lifting. Observe the safety regulations of the manufacturer of the means of transport or lifting. Noncompliance can result in personal injury or material damage.
- If you use the product in a vehicle, it is the sole responsibility of the driver to drive the vehicle safely and properly. The manufacturer assumes no responsibility for accidents or collisions. Never use the product in a moving vehicle if doing so could distract the driver of the vehicle. Adequately secure the product in the vehicle to prevent injuries or other damage in the event of an accident.



## Instrucciones de seguridad elementales

### Waste disposal/Environmental protection

1. Specially marked equipment has a battery or accumulator that must not be disposed of with unsorted municipal waste, but must be collected separately. It may only be disposed of at a suitable collection point or via a Rohde & Schwarz customer service center.
2. Waste electrical and electronic equipment must not be disposed of with unsorted municipal waste, but must be collected separately.  
Rohde & Schwarz GmbH & Co. KG has developed a disposal concept and takes full responsibility for take-back obligations and disposal obligations for manufacturers within the EU. Contact your Rohde & Schwarz customer service center for environmentally responsible disposal of the product.
3. If products or their components are mechanically and/or thermally processed in a manner that goes beyond their intended use, hazardous substances (heavy-metal dust such as lead, beryllium, nickel) may be released. For this reason, the product may only be disassembled by specially trained personnel. Improper disassembly may be hazardous to your health. National waste disposal regulations must be observed.
4. If handling the product releases hazardous substances or fuels that must be disposed of in a special way, e.g. coolants or engine oils that must be replenished regularly, the safety instructions of the manufacturer of the hazardous substances or fuels and the applicable regional waste disposal regulations must be observed. Also observe the relevant safety instructions in the product documentation. The improper disposal of hazardous substances or fuels can cause health problems and lead to environmental damage.

For additional information about environmental protection, visit the Rohde & Schwarz website.

## Instrucciones de seguridad elementales

### ¡Es imprescindible leer y cumplir las siguientes instrucciones e informaciones de seguridad!

El principio del grupo de empresas Rohde & Schwarz consiste en tener nuestros productos siempre al día con los estándares de seguridad y de ofrecer a nuestros clientes el máximo grado de seguridad. Nuestros productos y todos los equipos adicionales son siempre fabricados y examinados según las normas de seguridad vigentes. Nuestro sistema de garantía de calidad controla constantemente que sean cumplidas estas normas. El presente producto ha sido fabricado y examinado según el certificado de conformidad de la UE y ha salido de nuestra planta en estado impecable según los estándares técnicos de seguridad. Para poder preservar este estado y garantizar un funcionamiento libre de peligros, el usuario deberá atenerse a todas las indicaciones, informaciones de seguridad y notas de alerta. El grupo de empresas Rohde & Schwarz está siempre a su disposición en caso de que tengan preguntas referentes a estas informaciones de seguridad.

Además queda en la responsabilidad del usuario utilizar el producto en la forma debida. Este producto está destinado exclusivamente al uso en la industria y el laboratorio o, si ha sido expresamente autorizado, para aplicaciones de campo y de ninguna manera deberá ser utilizado de modo que alguna persona/cosa pueda sufrir daño. El uso del producto fuera de sus fines definidos o sin tener en cuenta las instrucciones del fabricante queda en la responsabilidad del usuario. El fabricante no se hace en ninguna forma responsable de consecuencias a causa del mal uso del producto.















## Instrucciones de seguridad elementales

Se parte del uso correcto del producto para los fines definidos si el producto es utilizado conforme a las indicaciones de la correspondiente documentación del producto y dentro del margen de rendimiento definido (ver hoja de datos, documentación, informaciones de seguridad que siguen). El uso del producto hace necesarios conocimientos técnicos y ciertos conocimientos del idioma inglés. Por eso se debe tener en cuenta que el producto solo pueda ser operado por personal especializado o personas instruidas en profundidad con las capacidades correspondientes. Si fuera necesaria indumentaria de seguridad para el uso de productos de Rohde & Schwarz, encontraría la información debida en la documentación del producto en el capítulo correspondiente. Guarde bien las informaciones de seguridad elementales, así como la documentación del producto, y entréguelas a usuarios posteriores.



Tener en cuenta las informaciones de seguridad sirve para evitar en lo posible lesiones o daños por peligros de toda clase. Por eso es imprescindible leer detalladamente y comprender por completo las siguientes informaciones de seguridad antes de usar el producto, y respetarlas durante el uso del producto. Deberán tenerse en cuenta todas las demás informaciones de seguridad, como p. ej. las referentes a la protección de personas, que encontrarán en el capítulo correspondiente de la documentación del producto y que también son de obligado cumplimiento. En las presentes informaciones de seguridad se recogen todos los objetos que distribuye el grupo de empresas Rohde & Schwarz bajo la denominación de "producto", entre ellos también aparatos, instalaciones así como toda clase de accesorios. Los datos específicos del producto figuran en la hoja de datos y en la documentación del producto.

### Señalización de seguridad de los productos

Las siguientes señales de seguridad se utilizan en los productos para advertir sobre riesgos y peligros.

Símbolo	Significado	Símbolo	Significado
	Aviso: punto de peligro general Observar la documentación del producto		Tensión de alimentación de PUESTA EN MARCHA / PARADA
	Atención en el manejo de dispositivos de peso elevado		Indicación de estado de espera (standby)
	Peligro de choque eléctrico		Corriente continua (DC)
	Advertencia: superficie caliente		Corriente alterna (AC)
	Conexión a conductor de protección		Corriente continua / Corriente alterna (DC/AC)
	Conexión a tierra		El aparato está protegido en su totalidad por un aislamiento doble (reforzado)
	Conexión a masa		Distintivo de la UE para baterías y acumuladores Más información en la sección "Eliminación/protección del medio ambiente", punto 1.

## Instrucciones de seguridad elementales

Símbolo	Significado	Símbolo	Significado
	Aviso: Cuidado en el manejo de dispositivos sensibles a la electrostática (ESD)		Distintivo de la UE para la eliminación por separado de dispositivos eléctricos y electrónicos  Más información en la sección "Eliminación/protección del medio ambiente", punto 2.
	Advertencia: rayo láser  Más información en la sección "Funcionamiento", punto 7.		

### Palabras de señal y su significado

En la documentación del producto se utilizan las siguientes palabras de señal con el fin de advertir contra riesgos y peligros.



Indica una situación de peligro que, si no se evita, causa lesiones graves o incluso la muerte.



Indica una situación de peligro que, si no se evita, puede causar lesiones graves o incluso la muerte.



Indica una situación de peligro que, si no se evita, puede causar lesiones leves o moderadas.



Indica información que se considera importante, pero no en relación con situaciones de peligro; p. ej., avisos sobre posibles daños materiales.

En la documentación del producto se emplea de forma sinónima el término CUIDADO.

Las palabras de señal corresponden a la definición habitual para aplicaciones civiles en el área económica europea. Pueden existir definiciones diferentes a esta definición en otras áreas económicas o en aplicaciones militares. Por eso se deberá tener en cuenta que las palabras de señal aquí descritas sean utilizadas siempre solamente en combinación con la correspondiente documentación del producto y solamente en combinación con el producto correspondiente. La utilización de las palabras de señal en combinación con productos o documentaciones que no les correspondan puede llevar a interpretaciones equivocadas y tener por consecuencia daños en personas u objetos.

### Estados operativos y posiciones de funcionamiento

*El producto solamente debe ser utilizado según lo indicado por el fabricante respecto a los estados operativos y posiciones de funcionamiento sin que se obstruya la ventilación. Si no se siguen las indicaciones del fabricante, pueden producirse choques eléctricos, incendios y/o lesiones graves con posible consecuencia de muerte. En todos los trabajos deberán ser tenidas en cuenta las normas nacionales y locales de seguridad del trabajo y de prevención de accidentes.*

## Instrucciones de seguridad elementales

1. Si no se convino de otra manera, es para los productos Rohde & Schwarz válido lo que sigue: como posición de funcionamiento se define por principio la posición con el suelo de la caja para abajo, modo de protección IP 2X, uso solamente en estancias interiores, utilización hasta 2000 m sobre el nivel del mar, transporte hasta 4500 m sobre el nivel del mar. Se aplicará una tolerancia de  $\pm 10\%$  sobre el voltaje nominal y de  $\pm 5\%$  sobre la frecuencia nominal. Categoría de sobrecarga eléctrica 2, índice de suciedad 2.
2. No sitúe el producto encima de superficies, vehículos, estantes o mesas, que por sus características de peso o de estabilidad no sean aptos para él. Siga siempre las instrucciones de instalación del fabricante cuando instale y asegure el producto en objetos o estructuras (p. ej. paredes y estantes). Si se realiza la instalación de modo distinto al indicado en la documentación del producto, se pueden causar lesiones o, en determinadas circunstancias, incluso la muerte.
3. No ponga el producto sobre aparatos que generen calor (p. ej. radiadores o calefactores). La temperatura ambiente no debe superar la temperatura máxima especificada en la documentación del producto o en la hoja de datos. En caso de sobrecalentamiento del producto, pueden producirse choques eléctricos, incendios y/o lesiones graves con posible consecuencia de muerte.

### Seguridad eléctrica

*Si no se siguen (o se siguen de modo insuficiente) las indicaciones del fabricante en cuanto a seguridad eléctrica, pueden producirse choques eléctricos, incendios y/o lesiones graves con posible consecuencia de muerte.*

1. Antes de la puesta en marcha del producto se deberá comprobar siempre que la tensión preseleccionada en el producto coincida con la de la red de alimentación eléctrica. Si es necesario modificar el ajuste de tensión, también se deberán cambiar en caso dado los fusibles correspondientes del producto.
2. Los productos de la clase de protección I con alimentación móvil y enchufe individual solamente podrán enchufarse a tomas de corriente con contacto de seguridad y con conductor de protección conectado.
3. Queda prohibida la interrupción intencionada del conductor de protección, tanto en la toma de corriente como en el mismo producto. La interrupción puede tener como consecuencia el riesgo de que el producto sea fuente de choques eléctricos. Si se utilizan cables alargadores o regletas de enchufe, deberá garantizarse la realización de un examen regular de los mismos en cuanto a su estado técnico de seguridad.
4. Si el producto no está equipado con un interruptor para desconectarlo de la red, o bien si el interruptor existente no resulta apropiado para la desconexión de la red, el enchufe del cable de conexión se deberá considerar como un dispositivo de desconexión. El dispositivo de desconexión se debe poder alcanzar fácilmente y debe estar siempre bien accesible. Si, p. ej., el enchufe de conexión a la red es el dispositivo de desconexión, la longitud del cable de conexión no debe superar 3 m). Los interruptores selectores o electrónicos no son aptos para el corte de la red eléctrica. Si se integran productos sin interruptor en bastidores o instalaciones, se deberá colocar el interruptor en el nivel de la instalación.
5. No utilice nunca el producto si está dañado el cable de conexión a red. Compruebe regularmente el correcto estado de los cables de conexión a red. Asegúrese, mediante las medidas de protección y de instalación adecuadas, de que el cable de conexión a red no pueda ser dañado o de que nadie pueda ser dañado por él, p. ej. al tropezar o por un choque eléctrico.

## Instrucciones de seguridad elementales

6. Solamente está permitido el funcionamiento en redes de alimentación TN/TT aseguradas con fusibles de 16 A como máximo (utilización de fusibles de mayor amperaje solo previa consulta con el grupo de empresas Rohde & Schwarz).
7. Nunca conecte el enchufe en tomas de corriente sucias o llenas de polvo. Introduzca el enchufe por completo y fuertemente en la toma de corriente. La no observación de estas medidas puede provocar chispas, fuego y/o lesiones.
8. No sobrecargue las tomas de corriente, los cables alargadores o las regletas de enchufe ya que esto podría causar fuego o choques eléctricos.
9. En las mediciones en circuitos de corriente con una tensión  $U_{\text{eff}} > 30 \text{ V}$  se deberán tomar las medidas apropiadas para impedir cualquier peligro (p. ej. medios de medición adecuados, seguros, limitación de tensión, corte protector, aislamiento etc.).
10. Para la conexión con dispositivos informáticos como un PC o un ordenador industrial, debe comprobarse que éstos cumplan los estándares IEC60950-1/EN60950-1 o IEC61010-1/EN 61010-1 válidos en cada caso.
11. A menos que esté permitido expresamente, no retire nunca la tapa ni componentes de la carcasa mientras el producto esté en servicio. Esto pone a descubierto los cables y componentes eléctricos y puede causar lesiones, fuego o daños en el producto.
12. Si un producto se instala en un lugar fijo, se deberá primero conectar el conductor de protección fijo con el conductor de protección del producto antes de hacer cualquier otra conexión. La instalación y la conexión deberán ser efectuadas por un electricista especializado.
13. En el caso de dispositivos fijos que no estén provistos de fusibles, interruptor automático ni otros mecanismos de seguridad similares, el circuito de alimentación debe estar protegido de modo que todas las personas que puedan acceder al producto, así como el producto mismo, estén a salvo de posibles daños.
14. Todo producto debe estar protegido contra sobretensión (debida p. ej. a una caída del rayo) mediante los correspondientes sistemas de protección. Si no, el personal que lo utilice quedará expuesto al peligro de choque eléctrico.
15. No debe introducirse en los orificios de la caja del aparato ningún objeto que no esté destinado a ello. Esto puede producir cortocircuitos en el producto y/o puede causar choques eléctricos, fuego o lesiones.
16. Salvo indicación contraria, los productos no están impermeabilizados (ver también el capítulo "Estados operativos y posiciones de funcionamiento", punto 1). Por eso es necesario tomar las medidas necesarias para evitar la entrada de líquidos. En caso contrario, existe peligro de choque eléctrico para el usuario o de daños en el producto, que también pueden redundar en peligro para las personas.
17. No utilice el producto en condiciones en las que pueda producirse o ya se hayan producido condensaciones sobre el producto o en el interior de éste, como p. ej. al desplazarlo de un lugar frío a otro caliente. La entrada de agua aumenta el riesgo de choque eléctrico.
18. Antes de la limpieza, desconecte por completo el producto de la alimentación de tensión (p. ej. red de alimentación o batería). Realice la limpieza de los aparatos con un paño suave, que no se deshilache. No utilice bajo ningún concepto productos de limpieza químicos como alcohol, acetona o diluyentes para lacas nitrocelulósicas.

## Instrucciones de seguridad elementales

### Funcionamiento

1. El uso del producto requiere instrucciones especiales y una alta concentración durante el manejo. Debe asegurarse que las personas que manejen el producto estén a la altura de los requerimientos necesarios en cuanto a aptitudes físicas, psíquicas y emocionales, ya que de otra manera no se pueden excluir lesiones o daños de objetos. El empresario u operador es responsable de seleccionar el personal usuario apto para el manejo del producto.
2. Antes de desplazar o transportar el producto, lea y tenga en cuenta el capítulo "Transporte".
3. Como con todo producto de fabricación industrial no puede quedar excluida en general la posibilidad de que se produzcan alergias provocadas por algunos materiales empleados —los llamados alérgenos (p. ej. el níquel)—. Si durante el manejo de productos Rohde & Schwarz se producen reacciones alérgicas, como p. ej. irritaciones cutáneas, estornudos continuos, enrojecimiento de la conjuntiva o dificultades respiratorias, debe avisarse inmediatamente a un médico para investigar las causas y evitar cualquier molestia o daño a la salud.
4. Antes de la manipulación mecánica y/o térmica o el desmontaje del producto, debe tenerse en cuenta imprescindiblemente el capítulo "Eliminación/protección del medio ambiente", punto 1.
5. Ciertos productos, como p. ej. las instalaciones de radiocomunicación RF, pueden a causa de su función natural, emitir una radiación electromagnética aumentada. Deben tomarse todas las medidas necesarias para la protección de las mujeres embarazadas. También las personas con marcapasos pueden correr peligro a causa de la radiación electromagnética. El empresario/operador tiene la obligación de evaluar y señalar las áreas de trabajo en las que exista un riesgo elevado de exposición a radiaciones.
6. Tenga en cuenta que en caso de incendio pueden desprenderse del producto sustancias tóxicas (gases, líquidos etc.) que pueden generar daños a la salud. Por eso, en caso de incendio deben usarse medidas adecuadas, como p. ej. máscaras antigás e indumentaria de protección.
7. Los productos con láser están provistos de indicaciones de advertencia normalizadas en función de la clase de láser del que se trate. Los rayos láser pueden provocar daños de tipo biológico a causa de las propiedades de su radiación y debido a su concentración extrema de potencia electromagnética. En caso de que un producto Rohde & Schwarz contenga un producto láser (p. ej. un lector de CD/DVD), no debe usarse ninguna otra configuración o función aparte de las descritas en la documentación del producto, a fin de evitar lesiones (p. ej. debidas a irradiación láser).
8. Clases de compatibilidad electromagnética (conforme a EN 55011 / CISPR 11; y en analogía con EN 55022 / CISPR 22, EN 55032 / CISPR 32)
  - Aparato de clase A:  
Aparato adecuado para su uso en todos los entornos excepto en los residenciales y en aquellos conectados directamente a una red de distribución de baja tensión que suministra corriente a edificios residenciales.  
Nota: Los aparatos de clase A están destinados al uso en entornos industriales. Estos aparatos pueden causar perturbaciones radioeléctricas en entornos residenciales debido a posibles perturbaciones guiadas o radiadas. En este caso, se le podrá solicitar al operador que tome las medidas adecuadas para eliminar estas perturbaciones.
  - Aparato de clase B:  
Aparato adecuado para su uso en entornos residenciales, así como en aquellos conectados directamente a una red de distribución de baja tensión que suministra corriente a edificios residenciales.

## Instrucciones de seguridad elementales

### Reparación y mantenimiento

1. El producto solamente debe ser abierto por personal especializado con autorización para ello. Antes de manipular el producto o abrirlo, es obligatorio desconectarlo de la tensión de alimentación, para evitar toda posibilidad de choque eléctrico.
2. El ajuste, el cambio de partes, el mantenimiento y la reparación deberán ser efectuadas solamente por electricistas autorizados por Rohde & Schwarz. Si se reponen partes con importancia para los aspectos de seguridad (p. ej. el enchufe, los transformadores o los fusibles), solamente podrán ser sustituidos por partes originales. Después de cada cambio de partes relevantes para la seguridad deberá realizarse un control de seguridad (control a primera vista, control del conductor de protección, medición de resistencia de aislamiento, medición de la corriente de fuga, control de funcionamiento). Con esto queda garantizada la seguridad del producto.

### Baterías y acumuladores o celdas

*Si no se siguen (o se siguen de modo insuficiente) las indicaciones en cuanto a las baterías y acumuladores o celdas, pueden producirse explosiones, incendios y/o lesiones graves con posible consecuencia de muerte. El manejo de baterías y acumuladores con electrolitos alcalinos (p. ej. celdas de litio) debe seguir el estándar EN 62133.*

1. No deben desmontarse, abrirse ni triturarse las celdas.
2. Las celdas o baterías no deben someterse a calor ni fuego. Debe evitarse el almacenamiento a la luz directa del sol. Las celdas y baterías deben mantenerse limpias y secas. Limpiar las conexiones sucias con un paño seco y limpio.
3. Las celdas o baterías no deben cortocircuitarse. Es peligroso almacenar las celdas o baterías en estuches o cajones en cuyo interior puedan cortocircuitarse por contacto recíproco o por contacto con otros materiales conductores. No deben extraerse las celdas o baterías de sus embalajes originales hasta el momento en que vayan a utilizarse.
4. Las celdas o baterías no deben someterse a impactos mecánicos fuertes indebidos.
5. En caso de falta de estanqueidad de una celda, el líquido vertido no debe entrar en contacto con la piel ni los ojos. Si se produce contacto, lavar con agua abundante la zona afectada y avisar a un médico.
6. En caso de cambio o recarga inadecuados, las celdas o baterías que contienen electrolitos alcalinos (p. ej. las celdas de litio) pueden explotar. Para garantizar la seguridad del producto, las celdas o baterías solo deben ser sustituidas por el tipo Rohde & Schwarz correspondiente (ver lista de recambios).
7. Las baterías y celdas deben reciclarse y no deben tirarse a la basura doméstica. Las baterías o acumuladores que contienen plomo, mercurio o cadmio deben tratarse como residuos especiales. Respete en esta relación las normas nacionales de eliminación y reciclaje.

### Transporte

1. El producto puede tener un peso elevado. Por eso es necesario desplazarlo o transportarlo con precaución y, si es necesario, usando un sistema de elevación adecuado (p. ej. una carretilla elevadora), a fin de evitar lesiones en la espalda u otros daños personales.

## Instrucciones de seguridad elementales

2. Las asas instaladas en los productos sirven solamente de ayuda para el transporte del producto por personas. Por eso no está permitido utilizar las asas para la sujeción en o sobre medios de transporte como p. ej. grúas, carretillas elevadoras de horquilla, carros etc. Es responsabilidad suya fijar los productos de manera segura a los medios de transporte o elevación. Para evitar daños personales o daños en el producto, siga las instrucciones de seguridad del fabricante del medio de transporte o elevación utilizado.
3. Si se utiliza el producto dentro de un vehículo, recae de manera exclusiva en el conductor la responsabilidad de conducir el vehículo de manera segura y adecuada. El fabricante no asumirá ninguna responsabilidad por accidentes o colisiones. No utilice nunca el producto dentro de un vehículo en movimiento si esto pudiera distraer al conductor. Asegure el producto dentro del vehículo debidamente para evitar, en caso de un accidente, lesiones u otra clase de daños.

### Eliminación/protección del medio ambiente

1. Los dispositivos marcados contienen una batería o un acumulador que no se debe desechar con los residuos domésticos sin clasificar, sino que debe ser recogido por separado. La eliminación se debe efectuar exclusivamente a través de un punto de recogida apropiado o del servicio de atención al cliente de Rohde & Schwarz.
2. Los dispositivos eléctricos usados no se deben desechar con los residuos domésticos sin clasificar, sino que deben ser recogidos por separado. Rohde & Schwarz GmbH & Co.KG ha elaborado un concepto de eliminación de residuos y asume plenamente los deberes de recogida y eliminación para los fabricantes dentro de la UE. Para desechar el producto de manera respetuosa con el medio ambiente, dirijase a su servicio de atención al cliente de Rohde & Schwarz.
3. Si se trabaja de manera mecánica y/o térmica cualquier producto o componente más allá del funcionamiento previsto, pueden liberarse sustancias peligrosas (polvos con contenido de metales pesados como p. ej. plomo, berilio o níquel). Por eso el producto solo debe ser desmontado por personal especializado con formación adecuada. Un desmontaje inadecuado puede ocasionar daños para la salud. Se deben tener en cuenta las directivas nacionales referentes a la eliminación de residuos.
4. En caso de que durante el trato del producto se formen sustancias peligrosas o combustibles que deban tratarse como residuos especiales (p. ej. refrigerantes o aceites de motor con intervalos de cambio definidos), deben tenerse en cuenta las indicaciones de seguridad del fabricante de dichas sustancias y las normas regionales de eliminación de residuos. Tenga en cuenta también en caso necesario las indicaciones de seguridad especiales contenidas en la documentación del producto. La eliminación incorrecta de sustancias peligrosas o combustibles puede causar daños a la salud o daños al medio ambiente.

Se puede encontrar más información sobre la protección del medio ambiente en la página web de Rohde & Schwarz.



# Quality management and environmental management

Certified Quality System  
**ISO 9001**

Certified Environmental System  
**ISO 14001**

## Sehr geehrter Kunde,

Sie haben sich für den Kauf eines Rohde&Schwarz Produktes entschieden. Sie erhalten damit ein nach modernsten Fertigungsmethoden hergestelltes Produkt. Es wurde nach den Regeln unserer Qualitäts- und Umweltmanagementsysteme entwickelt, gefertigt und geprüft. Rohde&Schwarz ist unter anderem nach den Managementsystemen ISO9001 und ISO 14001 zertifiziert.

## Der Umwelt verpflichtet

- Energie-effiziente, RoHS-konforme Produkte
- Kontinuierliche Weiterentwicklung nachhaltiger Umweltkonzepte
- ISO 14001-zertifiziertes Umweltmanagementsystem

## Dear customer,

You have decided to buy a Rohde&Schwarz product. This product has been manufactured using the most advanced methods. It was developed, manufactured and tested in compliance with our quality management and environmental management systems. Rohde&Schwarz has been certified, for example, according to the ISO9001 and ISO 14001 management systems.

## Environmental commitment

- Energy-efficient products
- Continuous improvement in environmental sustainability
- ISO 14001-certified environmental management system

## Cher client,

Vous avez choisi d'acheter un produit Rohde&Schwarz. Vous disposez donc d'un produit fabriqué d'après les méthodes les plus avancées. Le développement, la fabrication et les tests de ce produit ont été effectués selon nos systèmes de management de qualité et de management environnemental. La société Rohde&Schwarz a été homologuée, entre autres, conformément aux systèmes de management ISO 9001 et ISO 14001.

## Engagement écologique

- Produits à efficience énergétique
- Amélioration continue de la durabilité environnementale
- Système de management environnemental certifié selon ISO 14001



# Customer Support

## Technical support – where and when you need it

For quick, expert help with any Rohde & Schwarz equipment, contact one of our Customer Support Centers. A team of highly qualified engineers provides telephone support and will work with you to find a solution to your query on any aspect of the operation, programming or applications of Rohde & Schwarz equipment.

## Up-to-date information and upgrades

To keep your instrument up-to-date and to be informed about new application notes related to your instrument, please send an e-mail to the Customer Support Center stating your instrument and your wish. We will take care that you will get the right information.

### Europe, Africa, Middle East

Phone +49 89 4129 12345  
[customersupport@rohde-schwarz.com](mailto:customersupport@rohde-schwarz.com)

### North America

Phone 1-888-TEST-RSA (1-888-837-8772)  
[customer.support@rsa.rohde-schwarz.com](mailto:customer.support@rsa.rohde-schwarz.com)

### Latin America

Phone +1-410-910-7988  
[customersupport.la@rohde-schwarz.com](mailto:customersupport.la@rohde-schwarz.com)

### Asia/Pacific

Phone +65 65 13 04 88  
[customersupport.asia@rohde-schwarz.com](mailto:customersupport.asia@rohde-schwarz.com)

### China

Phone +86-800-810-8228 /  
+86-400-650-5896  
[customersupport.china@rohde-schwarz.com](mailto:customersupport.china@rohde-schwarz.com)



# Contents

<b>1 Introduction.....</b>	<b>5</b>
1.1 Base Unit and Optional Port Extension.....	5
1.2 About this Manual.....	5
<b>2 Putting the Instrument into Operation.....</b>	<b>7</b>
2.1 Instrument Tour.....	7
2.2 Preparing the Instrument.....	11
2.3 Connecting External Devices.....	18
<b>3 Instrument Functions.....</b>	<b>21</b>
3.1 Switch Module 2x6.....	21
3.2 Base Unit 2x6.....	22
3.3 Switch Matrix 4x12 (with R&S ZN-Z85-B24).....	23
<b>4 Application.....</b>	<b>25</b>
4.1 Matrix Setup and Operation at the R&S ZNx.....	26
4.2 RF Connections and Matrix Connectivity.....	26
4.3 Multiple Paths: Precision vs. Speed.....	28
<b>5 Operation.....</b>	<b>31</b>
5.1 Basic Information on Remote Control.....	31
5.2 Remote Control – Commands.....	35
<b>6 Maintenance.....</b>	<b>45</b>
<b>A ZN-Z8x User Tool.....</b>	<b>47</b>
A.1 Software Installation.....	47
A.2 Getting Started.....	48
A.3 Device Panel.....	49

<b>A.4 Test Tab.....</b>	<b>50</b>
<b>A.5 Settings Tab.....</b>	<b>51</b>
<b>A.6 System Monitor Tab.....</b>	<b>54</b>
<b>List of Commands.....</b>	<b>55</b>
<b>Index.....</b>	<b>56</b>

# 1 Introduction

The R&S ZN-Z85 is designed as an external switch matrix for the R&S ZNx family of vector network analyzers.

With its extended frequency range of 10 MHz to 20 GHz it is particularly suitable for the R&S ZNB20 models.

## 1.1 Base Unit and Optional Port Extension

The Base Unit implements a non-blocking 2x6 switch matrix, i.e. it allows to connect its 2 VNA ports to any 2 of its 6 test ports. With hardware option R&S ZN-Z85-B24, which adds 2 VNA ports and 6 test ports, it can be extended to a 4x12 switch matrix which is logically split into 2 separate 2x6 matrices.

For technical details see the R&S ZN-Z85 data sheet.

## 1.2 About this Manual

The user manual is included on the CD-ROM supplied with the delivery. Beyond the "getting started" chapters it contains descriptions of all instrument functions and of the remote control of the instrument. In addition, it contains notes on preventative maintenance for the R&S ZN-Z85 and on troubleshooting on the basis of the warnings and error messages that the instrument emits. Finally it contains a description of the ZN-Z8x User tool, which can also be found on the CD-ROM.

The user manual is organized into the following chapters:

- Putting the Instrument into Operation
- Instrument Functions
- Application
- Operation (via Remote Control)
- Maintenance
- Appendix

The most recent version is available on the [Internet](#).



## 2 Putting the Instrument into Operation

The R&S ZN-Z85 is designed as a base unit (2x6 switch matrix) that can be equipped with an optional port extension. The following description applies to both variants. Differences are pointed out explicitly where relevant.

The section below describes how to put the instrument into operation, connect external instruments and integrate the R&S ZN-Z85 into a network. General notes are provided to ensure safety while operating the instrument.

---

### **WARNING**

#### **Risk of injury and instrument damage**

The instrument must be used in an appropriate manner to prevent electric shock, fire, personal injury, or damage.

- Do not open the instrument casing.
  - Read and observe the "Basic Safety Instructions" at the beginning of this manual or on the documentation CD-ROM, in addition to the safety instructions in the following sections. Notice that the data sheet may specify additional operating conditions.
- 

### 2.1 Instrument Tour

This chapter shows all function keys, control elements and connections on the front and rear panel of the R&S ZN-Z85.

#### 2.1.1 Front Panel

The front panel of the switch matrix provides the administrative area on the left-hand side, and, to its right, the matrix VNA port area (including a USB type B connector) and the matrix test port area. Brief explanations on the controls and connectors can be found on the next pages.

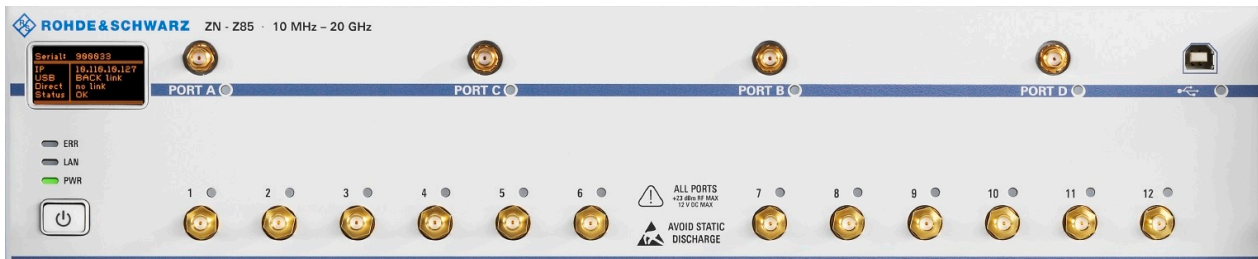

### 2.1.1.1 Mini display

```
Serial: 900033
IP      192.168.1.2
USB     BACK link
Direct  no link
Status  OK
```

The miniature display in the upper left-hand corner of the R&S ZN-Z85 provides the following instrument information:

- Serial number `Serial`
- IP address `IP` (see [chapter 2.3.2, "LAN"](#), on page 18)
- USB link state `USB: FRONT link, REAR link or no link` (see [chapter 2.3.1, "USB"](#), on page 18)
- Direct Control state `D.C.: link or no link` (see [chapter 2.3.3, "Direct Control"](#), on page 19)
- Operational status `STAT: OK or Error <error code>` (see [SYSTEM: ERRor?](#) on page 36 )

### 2.1.1.2 Status LEDs



Above the standby toggle switch some LEDs indicate various status information:

- ERR: operation state; if an error occurs, the LED lights up red
- LAN: LAN error occurred
- PWR: power state (ready/standby); see [chapter 2.2.6, "Turning the Instrument On and Starting"](#), on page 17



### 2.1.1.3 Standby Key

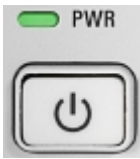

The key serves two main purposes:

- Toggle between standby and ready state; see [chapter 2.2.6, "Turning the Instrument On and Starting"](#), on page 17.  
When the instrument is powered up it comes up in ready state.
- Shut down the instrument; see [chapter 2.2.7, "Switching the Instrument Off"](#), on page 17.

### 2.1.1.4 Matrix VNA Ports

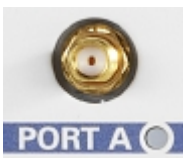

SMA female connectors, 50  $\Omega$ , labeled A, C, B, D (from left to right). A colored LED indicates whether the related port is currently used.

- With the R&S ZN-Z85 base unit only connectors A and B are available.
- With the optional 4-VNA-port extension R&S ZN-Z85-B24 connectors C and D are added.

### 2.1.1.5 Matrix Test Ports

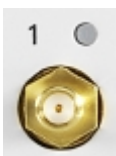

Numbered female SMA connectors (50  $\Omega$ ), serving as outputs for the RF stimulus signal and as inputs for the measured RF signals from the DUT (response signals).

- Without port extension the R&S ZN-Z85 base unit offers ports 1 to 6.
- Optional extension R&S ZN-Z85-B24 adds test ports 7 to 12.

It is recommended to use a suitable torque wrench when fastening the RF cables on the connectors.

If the related port is in use, the color of the LED indicates the connected VNA port. The LED colors can be set using the [ZN-Z8x User Tool](#) which can be found on the complementary CD.

**NOTICE****Maximum input levels**

The maximum input levels specified in the Data Sheet of the R&S ZN-Z85 must not be exceeded.

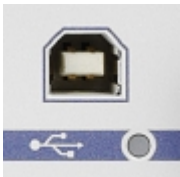
**2.1.1.6 USB Connector**

Two type B (slave) high speed USB connectors are provided on the R&S ZN-Z85: one at the front panel and one at the back panel. They can be used (exclusively) to control the R&S ZN-Z85 from the VNA.



- The front USB connector is linked by using an internal USB-Hub. For optimum switching speed it is recommended to use the back panel connector.
- The length of passive connecting USB cables should not exceed 1 m. See also the notice on EMI Suppression below (see [chapter 2.2.2, "Setting up the Instrument"](#), on page 12).

**2.1.2 Rear Panel**

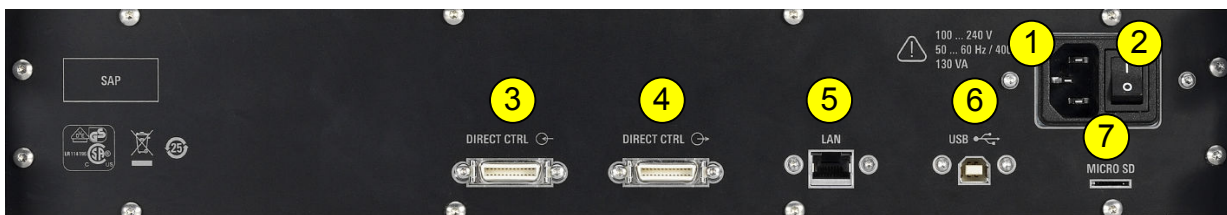

This section shows all interfaces on the back of the R&S ZN-Z85.



**Fig. 2-1: R&S ZN-Z85 rear view**

**Table 2-1: Rear panel elements**

Index	Label	Description
1		AC power connector
2	IO	Power switch

Index	Label	Description
3	DIRECT CTRL 	DIG-IQ connectors: Direct Control (Prog Bus) interface, incoming (from R&S ZNB/ZNBT) and outgoing (to other Direct Control devices). Allows a direct connection between the R&S ZNB/ZNBT measurement bus and the FPGA controlling the matrix switches, bypassing the microcontroller. This significantly reduces the switching times compared to management via USB or LAN.
4	DIRECT CTRL 	<b>Note:</b> requires the Device Control hardware option "B12" on the R&S ZNB/ZNBT.
5	LAN	RJ-45 connector to integrate the instrument to a Local Area Network, primarily for remote control purposes.
6	USB	Type B (slave) high speed USB connector to control the R&S ZN-Z85 from the VNA. See also <a href="#">chapter 2.1.1.6, "USB Connector"</a> , on page 10.
7	MICRO SD	Micro SD card slot

See the R&S ZN-Z85 Data Sheet for interface specification details.

## 2.2 Preparing the Instrument

This section covers the basic steps to set up the R&S ZN-Z85 and to put it into operation.

### CAUTION

#### Safety precautions

Be absolutely sure to follow the instructions in the sections below to prevent injury to people or damage to the instrument. This is particularly important the first time that you use the instrument. In addition, be sure to observe the general safety notes at the beginning of this manual.

## 2.2.1 Unpacking the Instrument

The instrument is delivered together with the accessories in a cardboard box. Proceed as follows to unpack its contents:

1. Remove the instrument from its packaging and check the shipment for completeness by comparing it with the shipping document and the accessory lists for the various items.
2. Remove the protective cover made of corrugated cardboard from the rear of the instrument.
3. A corrugated cardboard cover protects the front of the instrument; carefully unthread this cover from its location in the instrument handles and remove it.
4. Check the instrument for any damage. If there is any damage, immediately contact the shipping company that delivered the instrument. In this case, be absolutely certain that you keep the cardboard box and packing materials.



### Packing materials

We recommend that you retain the packaging. It is advisable to keep the original packing material in order to prevent control elements and connectors from being damaged if the instrument has to be transported or shipped at a later date.

---

## 2.2.2 Setting up the Instrument

This instrument is designed for indoor use. You can either set it up as a stand-alone instrument or mount it in a 19" rack.

**NOTICE****Possible damage to the instrument from overheating**

Restricted air current or excessively high ambient temperatures can cause the instrument to overheat.

To ensure sufficient air supply, all fan openings must be clear, and the air-flow at the vents on the sides of the instrument must not be impeded. The instrument must be positioned at least 10 cm away from the wall.

The ambient temperature must lie within the range specified in the data sheet.

**NOTICE****Potential damage caused by electrostatic discharge**

Electrical discharges can damage components of the instrument or a connected instrument under test.

For this reason, the instrument must only be operated at a workplace that is protected against electrostatic discharge.

The following methods can be used separately or in combination to protect against electrostatic discharges:

- Protective wrist strap with a ground conductor
- Conductive floor covering combined with use of a heel grounder

**NOTICE****EMI Suppression**

To suppress electromagnetic interference (EMI), the instrument may only be operated when it is closed and all covers are in place. The instrument's EMC rating is specified on the data sheet.

To prevent influences that cause disturbances, the following conditions must be adhered to:

- Use suitable double-shielded cables.
- Don't use any USB cables that are longer than 1 m.
- Only use USB devices that maintain the permitted EMC values.
- For the LAN connection, use CAT6 or CAT7 RJ-45 cables (LAN, Ethernet)

**2.2.3 Standalone Set Up**

The R&S ZN-Z85 can be set up on a level surface in a horizontal position or with the feet folded out.

**⚠ CAUTION****Risk of injury when the feet are folded out**

The feet can retract suddenly if the instrument is moved or if the feet are not completely folded out. This can lead to personal injuries or to damage to the instrument.

Instrument stability, and thus safe operation, is only ensured when the feet are completely folded out. When the feet are folded out, moving the instrument or performing work under it must be avoided. You must secure the instruments from slipping (for example, by locking the feet to the top of the front-panel frame).

If excessive loads are applied, the feet might break. The uniformly applied load to the feet when it is folded out must not exceed 500 N (including the weight of the instrument itself along with any equipment set on top of it).

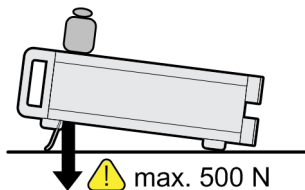

## 2.2.4 Mounting in a 19" Rack

The instrument is mounted into a 19" rack with the aid of a rack adapter (for order number, see product brochure). The mounting instructions are supplied with the adapter.

**NOTICE****Possible damage to the instrument from overheating**

Restriction of the air current at the side vents can cause the instrument to overheat.

To ensure sufficient air supply, all fan openings must be clear, and the air-flow at the vents on the sides of the instrument must not be impeded. The instrument must be positioned at least 10 cm away from the wall.

## 2.2.5 Connecting the R&S ZN-Z85 to the AC Power Supply

### NOTICE

#### Possible damage to the instrument

Before you connect the instrument and turn it on, you must ensure observance of the following points in order to prevent damage to the instrument:

- The housing covers must be in place, and their screws must be fastened.
- The ventilation openings must be clear; it must be ensured that air can freely exit at the back of the instrument and at the holes on the sides. The minimum distance to the wall should, therefore, be at least 10 cm.
- The instrument must be dry.
- The instrument should only be operated in the horizontal position on an even surface.
- The ambient temperature must be within the range specified in the data sheet.
- It must be ensured that none of the voltage levels at the inputs exceed permissible limits.
- Explanation:  
Measuring circuits as defined in section 6.7.4 of EN61010-1  
Measuring category I is intended for measurements on circuits that are not connected to the high-voltage current system.
- It must be ensured that the instrument outputs are not overloaded or incorrectly connected.

When the instrument is connected to the AC supply, it automatically adjusts to the AC supply voltage (see the labeling for the voltage range). It is not necessary to manually adjust the instrument to a specific voltage or to change the fuse.



## 2.2.6 Turning the Instrument On and Starting

### **⚠ CAUTION**

#### **Danger of electric shock**

The switch matrix complies with the specifications for the EN61010-1 protective class, which means that it can only be connected to a power outlet that has a protective contact.

1. Use the supplied power cable to connect the R&S ZN-Z85 to the AC power supply.



2. Switch the power switch to I.

The power switch has two positions:

- 0: The instrument is disconnected from the AC supply.
- I: The instrument is receiving power from the AC supply.

When the instrument receives power from the AC supply it immediately starts loading the firmware (mini display: "ZNZ85 FPGA loading...") and performs a self-test.

In standby state press the [Standby Key](#) to start the instrument.

As soon as the firmware is successfully loaded, the instrument is ready for operation and can be remotely controlled via USB or LAN and Direct Control.

## 2.2.7 Switching the Instrument Off

To switch the R&S ZN-Z85 off, press the [Standby Key](#) on the front of the instrument. The instrument switches to standby mode; only the POWER (standby) button remains active.

To disconnect the instrument completely from the AC supply, switch the power switch on the rear of the instrument to 0. Then disconnect the power cable at the AC power supply.

## 2.2.8 Function Check

The R&S ZN-Z85 automatically monitors the most important instrument functions when it is turned on.

## 2.3 Connecting External Devices

The R&S ZN-Z85 is equipped with different interfaces for establishing a remote control connection, typically from a VNA of the R&SZNx family.

### 2.3.1 USB

If required, connect the USB connecting cable to the USB type B (slave) port on the rear panel. With direct connection to a master device, a connecting cable A-B (plug type A onto plug type B) must be used.

### 2.3.2 LAN

The connection to the LAN is made using a commercially available RJ-45 cable via the LAN interface on the back of the instrument.

---

#### **NOTICE**

##### **Possible disturbance of network operation**

Only insert or remove the network cable when the instrument is turned off. That is the only way to ensure reliable detection of the network connection and avoid faults during operation of the instrument.

---

The network interface works with an 100 Mbit/s IEEE 802.3u Ethernet. The TCP/IP network protocol and the associated network services are preconfigured. In order to exchange data in a local area network (LAN), it must be possible to address each connected computer or instrument via a unique IP address or a hostname.

By default, every R&S ZN-Z85 is assigned a hostname `ZN-Z85X<serial number>`.

### 2.3.2.1 Networks with DHCP

The R&S ZN-Z85 is preconfigured to use the dynamic host configuration protocol (DHCP). In such networks, the R&S ZN-Z85 is automatically assigned a free IP address.

### 2.3.2.2 Static IP Configuration

With static IP configuration, the static IP configuration data are usually provided by the network administrator. They can be activated on the R&S ZN-Z85 using remote control.

### 2.3.2.3 Point-to-Point Connections

Establishing a simple network – a LAN connection between an R&S ZN-Z85 and a computer without integration into a larger network – requires assignment of an IP address for the R&S ZN-Z85 and the computer. The 192.168.xxx.yyy IP addresses are available for this. The values for xxx and yyy range from 1 to 254; the subnet mask length is 24 or higher. The IP address for the gateway must also be specified, but it is not of significance in this case.

## 2.3.3 Direct Control

The Direct Control interface allows to establish a direct connection between the measurement bus of a VNA of the R&S ZNx family and the FPGA controlling the routes of a switch matrix R&S ZN-Z8x. As Direct Control bypasses the matrice's microcontroller it significantly reduces the switching times compared to management via USB or LAN.



The R&S ZNB/ZNBT must be equipped with the Device Control option "B12".

---

The FPGA is put on the measurement bus by connecting the matrice's "Direct Control IN" interface to the analyzer's "DIRECT CTRL" interface; cascading of Direct Control connections is possible via "Direct Control OUT" (see [table 2-1](#)).

A suitable connection cable is provided with option R&S ZN-B121 (order no. 1323.9290.00).



## 3 Instrument Functions

The single function of a switch matrix R&S ZN-Z85 is to dynamically establish RF connections between its VNA ports (statically connected to the RF ports of the VNA) and its test ports (statically connected to the DUT), applying a passive load match to currently unconnected ports.

Typically these connections are requested by the connected VNA that ultimately wants to

- send a stimulus signal (the *a* wave) to a particular DUT port and to receive the response signal from the stimulated and other DUT ports (the *b* waves)
- and then quickly switch over to different stimulus/response ports.

Hence the switch matrix is completely remote-controlled; it does not provide any means for manual control.

The connection paths of the R&S ZN-Z85 (with or without optional port extension) are shown in simplified form in the circuit diagrams below.

### 3.1 Switch Module 2x6

The switching functionality of a R&S ZN-Z85 is provided by one or two non-blocking 2x6 switch modules.

At the "north" a 2x6 switch module provides 2 matrix VNA ports, at the "south" it provides 6 matrix test ports. Routes are established using RF semiconductor switches  $SP<n>T$  ( $n=3,4$ ), each of them allowing to set up bidirectional connections between its single "input port" to any of its  $n$  "output ports".

The switch module is non-blocking, i.e. the 2 matrix VNA ports can be simultaneously connected to any pair of test ports.

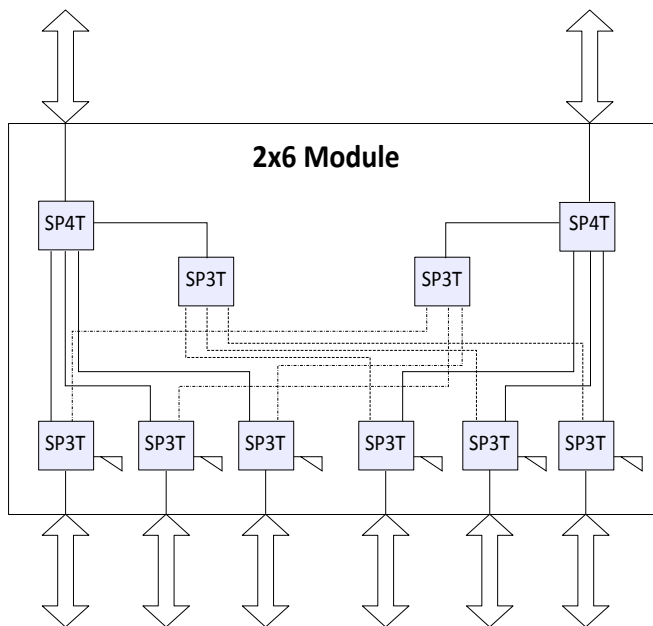

**Fig. 3-1: Switch Module 2x6**

To prevent reflections caused by misadjustment, 50  $\Omega$  terminating resistors are connected to unused outputs.

## 3.2 Base Unit 2x6

For a R&S ZN-Z85 Base Unit without extension, the switching functionality is provided by a single [Switch Module 2x6](#).

Switch Matrix 4x12 (with R&S ZN-Z85-B24)

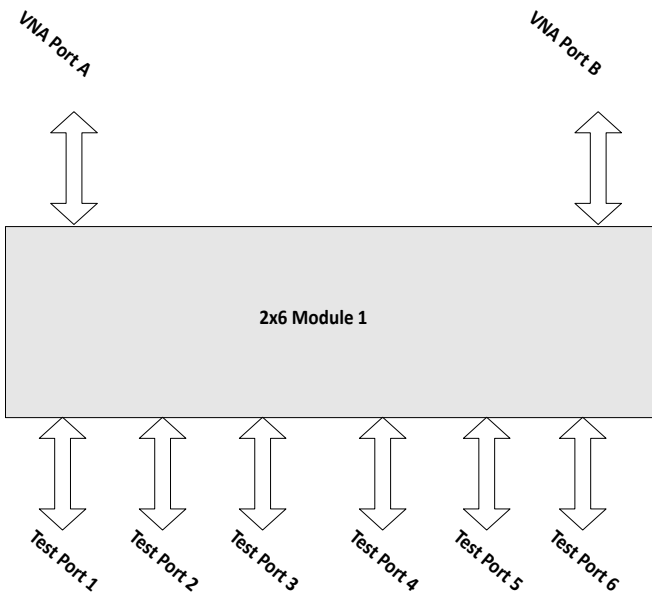

Fig. 3-2: Switch Matrix 2x6

### 3.3 Switch Matrix 4x12 (with R&S ZN-Z85-B24)

Option R&S ZN-Z85-B24 adds a second **Switch Module 2x6**, providing two additional physical VNA ports and test ports 7 to 12.

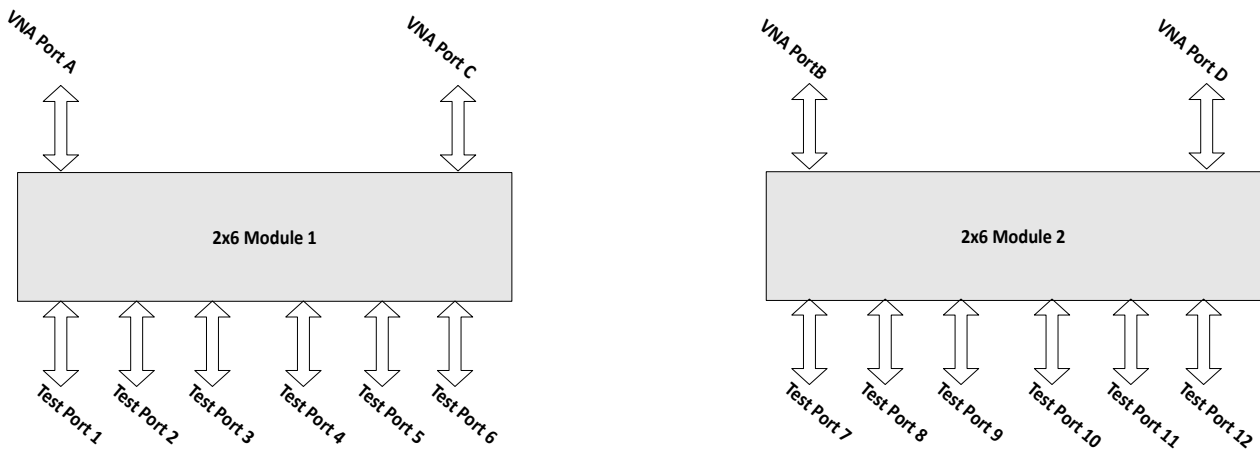

Fig. 3-3: Switch Matrix 4x12

Switch Matrix 4x12 (with R&S ZN-Z85-B24)



## 4 Application

From the perspective of the VNA, the purpose of a switch matrix is to extend the number of test ports, i.e. to convert an N-port network analyzer into an N'-port network analyzer ( $N' > N$ ) without modifying the instrument itself. The increased number of test ports can reduce or even eliminate the manual reconnections of the DUT, resulting in a higher measurement speed, reliability and repeatability.

The firmware of the R&S ZNx family is able to control switch matrices from Rohde&Schwarz directly. It is fast and easy to set up and operate a switch matrix via the graphical user interface. For example, a R&S ZNB in combination with a R&S ZN-Z85 can seamlessly work as a multi-port network analyzer with up to 12 ports.

However, an N-port analyzer is always limited to measuring N signals simultaneously, i.e. during stimulation by the active test port, even though the DUT is fully connected to the switch matrix, it may not be possible to measure all b-waves simultaneously. For example, consider a DUT with 6 unbalanced ports, connected to a 2-port analyzer via the R&S ZN-Z85 base unit without extension. For each stimulus port, 5 sweeps are required to measure the resulting b-waves,  $6 \cdot 5 = 30$  sweeps in total. For "real" 6-port analyzers, a single sweep per driving port is sufficient.

Furthermore, in the example above, at least  $6 \cdot 5 / 2$  successive matrix switching procedures are required (one for each port pair). This involves command processing and physical switching and hence might take some time to complete. To optimize the measurement setup w.r.t. speed and resources, the characteristics of the available switch matrices have to be taken into account.



- Matrix support is **not** available for R&S ZNC and R&S ZND.
  - The **Direct Control** access to the R&S ZN-Z85 eliminates the protocol and command processing overhead of the standard remote control interfaces and hence significantly reduces the total switching time.
  - While it is allowed to connect multiple matrices to a single analyzer of the R&S ZNx family, matrix cascading at RF layer is **not** supported.
-

## 4.1 Matrix Setup and Operation at the R&S ZNx

Setting up a switch matrix at the R&S ZNx firmware typically involves the following steps:

1. establish the physical connection via the appropriate management interface (USB, LAN or Direct Control)
2. register the matrix (as managed object)
3. define the RF configuration:
  - a) configure the matrix-VNA-connections according to the existing (or planned) physical connections between VNA test ports and matrix VNA ports
  - b) assign the matrix test ports and the remaining VNA ports (i.e. those that are not connected to a matrix VNA port) to DUT test ports

After this initial setup, the analyzer takes control of the attached matrices: it configures the test ports and dynamically establishes the required matrix through-connections according to the current measurement task.

## 4.2 RF Connections and Matrix Connectivity

Depending on the expansion stage of the R&S ZN-Z85 and the RF connections between VNA and matrix

- certain matrix test ports may not be available for measurements
- certain transmission measurements may not be possible

**Example:**

Consider a fully equipped R&S ZN-Z85, where the matrix VNA ports of the left submatrix cannot be connected to the test ports of the right submatrix and vice versa.

If none of the two VNA ports of a submatrix is connected, obviously no connection between the VNA and the submatrice's test ports can be established and hence neither reflection nor transmission measurements are possible.

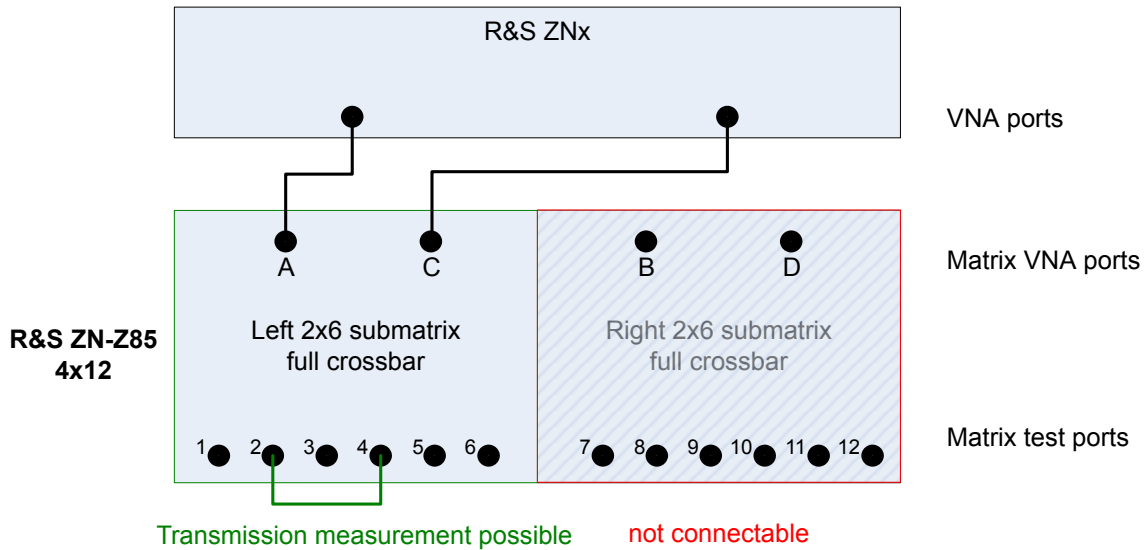

**Fig. 4-1: Unconnected right submatrix**

Connecting one of two submatrix VNA ports enables reflection measurements for the corresponding matrix test ports. However, as long as a second connection between the VNA and this submatrix is missing, "intra-submatrix" transmission measurements are still impossible.

Multiple Paths: Precision vs. Speed

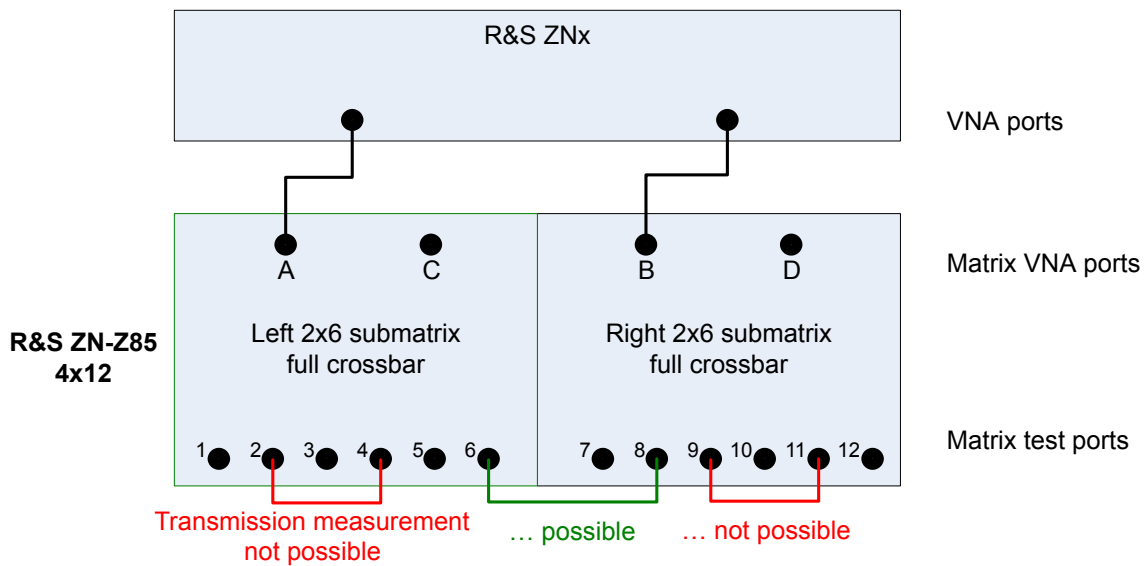

Fig. 4-2: Partially connected submatrices

### 4.3 Multiple Paths: Precision vs. Speed

On the other hand, the switch matrix offers multiple routes to a given matrix test port and hence measurements may be performed using different physical paths (where a *path* consists of the traversed VNA connections and matrix routes).

These paths have different characteristics - in particular if the corresponding matrix routes differ in the number of switches being traversed.

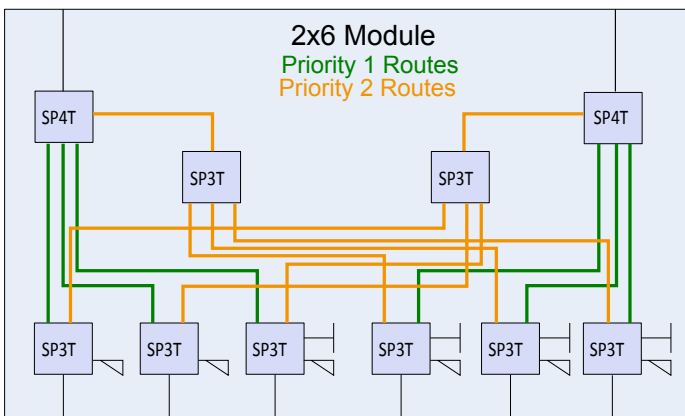

Fig. 4-3: Routes and priorities

## Multiple Paths: Precision vs. Speed

The R&S ZNx firmware prioritizes the available routes according to the number of switches they traverse:

- To obtain highest measurement *precision*, the driving VNA port should always use the "best possible" (highest priority) route. On the other hand this may cause additional matrix switching procedures and hence may result in a reduced measurement speed.
- If the focus is on measurement *speed*, the number of matrix switching procedures should be minimized, disregarding a possible loss in measurement precision.

As for "slow" management connections the trade-off between precision and speed cannot be resolved, the R&S ZNx firmware allows to select which optimization should be performed.

To see the difference between the two optimizations, again consider a DUT with 6 unbalanced ports, connected to a 2-port analyzer via the R&S ZN-Z85 base unit without extension. If all S-parameters shall be measured, at least  $6 \cdot 5 / 2$  successive matrix switching procedures are required (one for each pair of test ports) and the *speed* optimization would choose one of these minimum solutions. In contrast, the *precision* optimization always selects the priority 1 route for the driving port, which results in  $6 \cdot 5$  successive matrix switches (one per *directed* port pair).



Always choose the *precision* optimization if R&S ZNx and R&S ZN-Z85 are connected using [Direct Control](#). The switching speed of the matrix in this case is in the same range as the source switch of the VNA.

---



## 5 Operation

The switch matrix R&S ZN-Z85 is completely remote-controlled; it does not provide any means for manual control.

The RF port LEDs indicate the currently switched route(s) between matrix VNA ports and matrix test ports. The PWR LED on the front panel indicates the standby state of the instrument. The front panel USB is equipped with a LED that is lit while a connection is active.

The R&S ZN-Z85 is equipped with a 128x64 monochrome OLED-Display that displays the following information:

- Serial number of the instrument (for identification purposes)
- IP address
- USB and Direct Control link states
- Operational state of the instrument. This can be either
  - OK if the instrument is error-free or
  - ERROR <error code> with the error code of the last occurred error.

The following sections describe the steps and commands required for remote control of the switch matrix R&S ZN-Z85.

In [chapter 5.1, "Basic Information on Remote Control"](#), on page 31 you will find information on setting up the switch matrix for remote control and on the available interfaces and protocols. You will also find a brief description of the status register. The remote control commands are explained in detail in [chapter 5.2, "Remote Control – Commands"](#), on page 35.

### 5.1 Basic Information on Remote Control

This chapter contains basic information on remote control of the switch matrix R&S ZN-Z85. It contains instructions for setting up the instrument for remote control and a brief description of the status register.

#### 5.1.1 Interfaces and protocols

The instrument has different interfaces for remote control. The following table provides an overview:

**Table 5-1: Remote control interfaces and protocols**

Interface	Comments
USB	On the back of the instrument, there is a type B USB interface (slave) for communication with the master device. For details see <a href="#">chapter 5.1.1.2, "USB Interface"</a> , on page 33.
Local Area Network (LAN)	The LAN port is located at the backplane of the instrument. The LAN interface supports a RAW TCP/IP protocol at port 2101. All LAN parameters can be set using SCPI commands or via USB using the <a href="#">ZN-Z8x User Tool</a> which can be found on the complementary CD. For details see <a href="#">chapter 5.1.1.3, "LAN Interface"</a> , on page 34

### Standard Commands for Programmable Instruments (SCPI)

For remote control of the instrument, commands in line with the SCPI standard are used. The syntax of commands that are not included in that standard still follows the SCPI rules. The instrument supports SCPI version 1999 (Standard Commands for Programmable Instruments). The SCPI standard is built on the foundation of the IEEE 488.2 standard, and it aims to standardize instrument-specific commands, error handling and status register. For further information on SCPI concepts and definitions, please refer to the book "Automatic Measurement Control – A tutorial on SCPI and IEEE 488.2" by John M. Pieper, R&S order number 0002.3536.00.



This description of the remote control functionality assumes that you have a knowledge of programming and understand how to operate the controller. You will find detailed information on syntax and on the interface commands in the SCPI descriptions mentioned above.

#### 5.1.1.1 Commands and Responses

**Commands** are messages that the controller sends to the instrument. They operate the instrument functions and request information. The commands are divided into types based on two criteria:

- On the basis of the effect that they have on the instrument
  - **Setting commands** control instrument settings, such as resetting the instrument, or entering setting values.
  - **Query commands** make output data for the remote control, for example for identifying the instrument or for querying a setting's value. Queries have a question mark ? at the end of the setting command.



## Basic Information on Remote Control

- On the basis of how they are defined in the IEEE 488.2 and SCPI standards:
  - **Common commands** are precisely defined with regard to their function and syntax in the IEEE 488.2 standard. These commands are identical for all instruments, and they refer to functions such as the management of the standardized status register, resetting and self-testing.
  - **Instrument-dependent commands** are for functions that depend on the characteristics of the specific instrument, such as frequency setting. Many of these commands have also been standardized by the SCPI Consortium. Such commands are labeled "SCPI compliant" in the command reference. Commands without the SCPI label are instrument-dependent, however, their syntax follows the SCPI rules, as allowed by the standard.

**Responses** are messages that the instrument transmits to the controller after a query command. Responses contain measurement results, instrument settings or status information on the instrument.

You will find detailed descriptions of the commands for controlling the R&S ZN-Z85 in [chapter 5.2, "Remote Control – Commands"](#), on page 35.

### 5.1.1.2 USB Interface

For remote control via the USB bus, connect the controller (master) to the R&S ZN-Z85's type B USB interface.

Instrument control requires the generic `USBBULK.dll` and the instrument-specific `znz8x_dll.dll`. These are part of the R&S ZNx firmware and are also installed with the [ZN-Z8x User Tool](#) that can be found on the complementary CD.

#### USB address

To establish a USB connection, you need

- the **vendor ID** `0x0AAD` (for Rohde & Schwarz)
- the R&S ZN-Z85's **product ID** `0x011B` and
- the instrument's 6-digit serial number (see mini display or label on the back of the instrument)

### 5.1.1.3 LAN Interface

The instrument is equipped with a LAN interface to enable integration into a local area network (LAN). This interface consists of a connector, a network card, and protocols.

For remote control via the network, the controller and the instrument must be connected via the LAN interface to a common network that uses the TCP/IP network protocol. They are connected using commercially available RJ-45 cables. The TCP/IP network protocol and the network services associated with it are preconfigured on the instrument.

To establish the connection, you need the instrument's IP address or computer name.

#### Socket Communication

An alternative way for remote control of the software is to establish simple network communication using sockets (also referred as "Raw Ethernet communication").

The simplest way to establish a socket communication to the switch matrix is to connect to the built-in Telnet server. A Telnet client is part of every operating system and supports communication with the server on a command-by-command basis. For better utilization and to enable automation by means of programs, user-defined sockets can be programmed.

Socket connections are established on a specially defined port. The socket address is a combination of the IP address or the instrument's host name and the number of the port configured for remote control. All switch matrices use port number 2101 for this purpose. The port is configured for communication on a command-to-command basis and for remote control by a program.

## 5.1.2 Status Reporting System

The status reporting system stores all information on the instrument's current status and on the errors that have arisen. This information is stored in the status register and in an error output queue that can be queried using the `SYSTEM:ERROR?` command.

## 5.2 Remote Control – Commands

This chapter describes all the commands that are relevant for remote control of the switch matrix R&S ZN-Z85. The "List of Commands" at the end of the manual contains all commands in alphabetic order.



### Tips and tricks for operation ...

- **The use of upper and lower case letters** designates the long and short forms of a command: `SET:LAN:SNMask` = `SET:LAN:SNM`
- **Text parameters** are separated from the header by a space. They follow the strict syntax rules for keywords.
- Results are returned as ASCII strings terminated with `<CR><LF>` (ASCII 13 followed by ASCII 10)
- Optional **Handshake** (enabled by default)

### 5.2.1 Handshake

If Handshake is active, on successful execution of a command that otherwise does not return a result, a confirmation `0, "OK"<CR><LF>` is returned.

<code>HANDshake?</code> .....	35
<code>HANDshake:ON</code> .....	35
<code>HANDshake:OFF</code> .....	35

#### **HANDshake?**

Queries whether Handshake is ON (default) or OFF.

#### **Return values:**

`<Boolean>`                      Either 0 (OFF) or 1 (ON)  
    \*RST:                      1 (ON)

**Usage:**                              Query only

#### **HANDshake:ON**

#### **HANDshake:OFF**

Enables/disables the Handshake logic.

A successful command execution is answered by the handshake confirmation 0, "OK"<CR><LF>.

**Usage:** Event

## 5.2.2 General Functions

*RST.....	36
SYSTem:CLEAr.....	36
SYSTem:ERRor?.....	36

---

### \*RST

Sets the instrument to a defined default state:

- **Handshake** is turned ON
- all existing **Routes** are disconnected

**Usage:** Event

---

### SYSTem:CLEAr

Clears the error memory.

**Usage:** Event

---

### SYSTem:ERRor?

Queries the R&S ZN-Z85 for a list of errors.

#### Return values:

<ErrCodes> A list of error numbers (see table below)

**Usage:** Query only

**Table 5-2: R&S ZN-Z85 Error Codes**

Error Code	Error String	Description
0	ZNZ85_STATUS_OK	
1	ZNZ85_STATUS_UNKNOWN_OPT	unknown extension module
2	ZNZ85_STATUS_OPT_ERROR	extension module doesn't match available option codes

## Remote Control – Commands

Error Code	Error String	Description
3	ZNZ85_STA- TUS_FPGA_ERROR	can't read from FPGA registers
4	ZNZ85_STA- TUS_SD_CARD_ERROR	SD card corrupted (selftest failed)
5	ZNZ85_STA- TUS_NOR_FLASH_ERROR	NOR flash corrupted (selftest failed)
6	ZNZ85_STATUS_CON- FIG_FILE_ERROR	config.ini corrupted (inconsistent config.ini file)
7	ZNZ85_STA- TUS_FPGA_FALLBACK_LOADED	productive FPGA corrupted, fallback loaded
8	ZNZ85STA- TUS_FPGA_IRQ_ACTIVE	FPGA triggered a system monitor IRQ
9	ZNZ85_STA- TUS_FPGA_TIMEOUT_LOADING	FPGA loading timeout, e.g. old FPGA not triggering PROG-BUS_FPGA_LOADED_GPIO
10	ZNZ85_STA- TUS_FPGA_INCOMPATIBLE_VERSION	FPGA version is not compatible with µC version
11	ZNZ85_STA- TUS_MATRIX_FILE_ERROR	matrix.ini corrupted (inconsistent matrix.ini file)
20	ZNZ85_STA- TUS_FPGA_TEMPALARM	temperature alarm FPGA
21	ZNZ85_STA- TUS_VCC_AUX9_OUT- RANGE	Voltage difference between -12 V and +6 V is out of range
22	ZNZ85_STA- TUS_VCC_AUX10_OUT- RANGE	Voltage difference between -12 V and +5 V (2x6 Modules 1 and 2) is out of range
23	ZNZ85_STA- TUS_VCC_AUX11_OUT- RANGE	Voltage difference between -12 V and +5 V (2x6 Modules 3 and 4) is out of range
24	ZNZ85_STA- TUS_VCC_AUX14_OUT- RANGE	Voltage difference between -9V7 and +3V3 (2x6 Modules 1 and 2) is out of range
25	ZNZ85_STA- TUS_VCC_AUX15_OUT- RANGE	Voltage difference between -9V7 and +2V5 (2x6 Modules 3 and 4) is out of range
26	ZNZ85_STA- TUS_VCC_AUX6_OUT- RANGE	Voltage difference between +1V0 and Ground is out of range

Error Code	Error String	Description
27	ZNZ85_STA-TUS_VCC_INT_OUTRANGE	Internal FPGA voltage of +1.2 V is out of range
28	ZNZ85_STA-TUS_VCC_AUX_OUTRANGE	AUX. FPGA voltage of +2.5 V is out of range

### 5.2.3 Identification

*IDN?.....	38
*OPT?.....	38
*SERial?.....	39

#### \*IDN?

**IDENTIFICATION QUERY** queries the instrument identification string.

#### Return values:

<ID\_Str> ROHDE&SCHWARZ, ZN-Z85-<opt>, <serial>, <fw version>, where  
 <opt> is the option characterizing the expansion stage: 02 or 03 for the Base Unit without expansion (order no. 1326.4777.**02** for R&S ZN-Z85 variant 02, 1326.4777.**03** for variant 03), 24 or 26 with the 4x12 expansion (order no. 1326.4831.**24** for R&S ZN-Z85 variant 02, 1326.4831.**26** for R&S ZN-Z85 variant 03).  
 <serial> is the 6 digit serial number (see [Mini display](#) or SAP label on the rear panel).  
 <fw version> is the installed firmware version in "xx.yy" dotted decimal notation (xx: major version; yy: minor version).

**Usage:** Query only

**Manual operation:** See "[Identification String](#)" on page 50

#### \*OPT?

**OPTION IDENTIFICATION QUERY** queries the options contained in the instrument and returns a list of the installed options.

**Return values:**

<options>                   "/"-separated list of options, e.g. Installed Options:  
Basic/B24 for the 4x12 extension.

**Usage:**                    Query only

**Manual operation:**    See "[Installed Options](#)" on page 50

**\*SERial?**

Returns the serial number of the instrument.

**Return values:**

<Value>                    6 digit serial number, see mini display and SAP label on  
the back panel

**Usage:**                    Query only

**5.2.4 LAN Interface**

The following commands get/set the properties of the LAN interface.



Modified LAN settings are not applied until [SET:LAN:INIT](#) is executed.

To make the changes permanent, use [WRITE:MXINI](#).

<a href="#">SET:LAN:HOST:NAME</a> .....	40
<a href="#">SHOW:LAN:HOST:NAME?</a> .....	40
<a href="#">SHOW:LAN:MAC:ADDRESS?</a> .....	40
<a href="#">SHOW:LAN:DHCP?</a> .....	40
<a href="#">SET:LAN:DHCP:ON</a> .....	40
<a href="#">SET:LAN:DHCP:OFF</a> .....	40
<a href="#">SET:LAN:GW</a> .....	41
<a href="#">SHOW:LAN:GW?</a> .....	41
<a href="#">SET:LAN:IP</a> .....	41
<a href="#">SHOW:LAN:IP?</a> .....	41
<a href="#">SET:LAN:SNMask</a> .....	41
<a href="#">SHOW:LAN:SNMask?</a> .....	41
<a href="#">SET:LAN:INIT</a> .....	42

---

**SET:LAN:HOST:NAME** <HostName>**SHOW:LAN:HOST:NAME?**

Queries/sets the hostname of the switch matrix R&S ZN-Z85.

If the switch matrix uses DHCP and the DHCP server supports DHCP Option 12, the switch matrix can also be reached via this hostname.

**Parameters:**

<HostName>                    The LAN hostname string (max. 20 characters).  
The default hostname is ZNZ85X<serial>.

**Manual operation:**    See "[Hostname](#)" on page 53

---

**SHOW:LAN:MAC:ADDRESS?**

Queries the LAN MAC address of the switch matrix R&S ZN-Z85.

**Return values:**

<MACAddress>                The LAN MAC address in the format  
xx-xx-xx-xx-xx-xx, e.g. 00-90-b8-1c-95-b9.

**Usage:**                    Query only

---

**SHOW:LAN:DHCP?**

Queries whether DHCP is enabled.

**Return values:**

<DHCP>                      1: DHCP enabled  
0: DHCP disabled (static IP configuration)

**Usage:**                    Query only

**Manual operation:**    See "[IP Setting](#)" on page 52

---

**SET:LAN:DHCP:ON****SET:LAN:DHCP:OFF**

Enables/disables dynamic host configuration.

**Usage:**                    Event

**Manual operation:**    See "[IP Setting](#)" on page 52

---



**SET:LAN:GW** <GWIP>**SHOW:LAN:GW?**

Sets/queries the LAN default gateway.

Setting is only possible with static IP configuration ([SET:LAN:DHCP:OFF](#)). Otherwise the R&S ZN-Z85 answers with a "Deactivate DHCP first!"

**Note** that modified LAN settings are not applied until [SET:LAN:INIT](#) on page 42 is executed.

**Parameters:**

<GWIP>                      The IP address of the default gateway in dotted decimal format, e.g. 192.168.1.2.

**Manual operation:**    See "[IP address / Subnet Mask / Standard Gateway](#)" on page 52

---

**SET:LAN:IP** <IpAddr>**SHOW:LAN:IP?**

Sets/queries the LAN IP address.

Setting is only possible with static IP configuration ([SET:LAN:DHCP:OFF](#)). Otherwise the R&S ZN-Z85 answers with a "Deactivate DHCP first!"

**Note** that modified LAN settings are not applied until [SET:LAN:INIT](#) on page 42 is executed.

**Parameters:**

<IpAddr>                    The LAN IP address in dotted decimal format, e.g. 192.168.0.254.

**Manual operation:**    See "[IP address / Subnet Mask / Standard Gateway](#)" on page 52

---

**SET:LAN:SNMask** <SnMask>**SHOW:LAN:SNMask?**

Sets/queries the LAN subnet mask.

Setting is only possible with static IP configuration ([SET:LAN:DHCP:OFF](#)). Otherwise the R&S ZN-Z85 answers with a "Deactivate DHCP first!"

**Note** that modified LAN settings are not applied until `SET:LAN:INIT` on page 42 is executed.

**Parameters:**

<SnMask>                    The LAN subnet mask in dotted decimal format, e.g.  
255.255.255.0.

**Manual operation:**    See "IP address / Subnet Mask / Standard Gateway" on page 52

### SET:LAN:INIT

Activates the previously configured LAN settings (DHCP, IP address, subnet mask, default gateway).

Use the `WRITE:MXINI` command to persist the LAN settings.

**Usage:**                    Event

**Manual operation:**    See "Apply LAN Settings (nonpermanent)" on page 53

## 5.2.5 Routes

<code>ROUTE</code> .....	42
<code>SHOW:ROUTEs?</code> .....	43

### ROUTE

Creates a set of RF routes (connections from matrix VNA ports to matrix test ports) or queries the existing routes.

**Note** that during route creation,

- existing routes are deleted
- unconnected matrix test ports are terminated with a 50 Ω match

If the new route set was successfully created, the SET command returns the created routes exactly as the query would do.

If the new route set is invalid, either because it is empty, involves non-existing ports or contains multiple routes for the same port(s), an 1, "ROUTE ERROR" is returned and the existing routes are preserved.

**Parameters:**

&lt;Routes&gt;

Non-empty, comma-separated list of routes [A-D][0-12], where each route is determined by a matrix VNA port [A-D] and its connected matrix test port [0-12], for example ROUTe A1,B2 connects matrix VNA Port A with matrix test port 1 and matrix VNA Port B with matrix test port 2. Matrix test port 0 means the related matrix VNA port is "not connected"; in queries, both unequipped and unconnected matrix VNA ports are indicated as being connected to matrix test port 0.

**Example:**

In a 2xN switch matrix create a single route between matrix VNA port A and matrix test port 1:

```
ROUTe A1
```

A subsequent Route? will return A1,B0,C0,D0.

```
ROUTe A0
```

deletes all routes.

**Manual operation:** See "[Routes / Reset](#)" on page 51

**SHOW:ROUTes?**

Returns the list of all possible routes

**Return values:**

Routes

Comma-separated list of all possible routes.  
E.g. in the 2x6 base matrix the return value is  
A1,A2,A3,A4,A5,A6,B1,B2,B3,B4,B5,B6

**Usage:**

Query only

**Manual operation:** See "[Routes / Reset](#)" on page 51

**5.2.6 Other****SHOW:DIRectcon:STATUs?**

Queries the status of the Direct Control interface.

**Return values:**

&lt;StatusCode&gt;

Either 0, "D.C. not linked" or 1, "D.C. linked"

**Usage:**

Query only

**WRITE:MXINI**

Writes the current user settings (LAN), to the matrix flash. These settings are loaded during instrument startup.

**Usage:** Event

**Manual operation:** See "[Write all settings to ZN-Z85 \(permanent\)](#)" on page 53

## 6 Maintenance

The switch matrix R&S ZN-Z85 does not require maintenance at regular intervals. Maintenance work is essentially limited to cleaning the instrument.

---

**⚠ CAUTION****Danger of electric shock**

Before cleaning, make sure that the instrument is switched off and that it is disconnected from all power supplies.

---

**NOTICE****Instrument damage caused by cleaning agents**

Cleaning agents contain substances that may damage the instrument. For example, cleaning agents that contain a solvent may damage the front panel labeling, plastic parts, or the display.

Never use cleaning agents such as solvents (thinners, acetone, etc), acids, bases, or other substances.

The outside of the instrument can be cleaned sufficiently using a soft, lint-free dust cloth.

---

**Service work**

Replacing modules and ordering spare parts is described in the service manual. There you will also find all the ID numbers required for ordering spare parts.

In addition, the service manual contains information on troubleshooting, repairs and replacing modules.

**Packing and storage**

The storage temperature for the R&S ZN-Z85 is specified in the data sheet. When storing for longer periods, protect the instrument from dust.

Prior to transport or shipping, pack the instrument just as it was originally packed. The two protective covers guard the controls and connections against damage. The anti-static packaging film prevents undesired electrostatic charges.

If you no longer have the original packaging, employ a sturdy cardboard box of a suitable size. Ensure that there is enough padding to keep the instrument from slipping around inside the package. Wrap the instrument in anti-static film to protect it against electrostatic charging.

# A ZN-Z8x User Tool

The "ZN-Z8x User" tool offers the following functions:

- Connect to a R&S ZN-Z8x switch matrix via USB
  - Select a detected switch matrix
  - Read its identification parameters (extension type, serial number, firmware version)
- Create and delete routes manually
- Send SCPI commands and read the responses
- Read and modify LAN Settings
- Read and modify LED settings for the available RF ports
- Monitor system parameters:
  - FPGA temperature
  - voltages at certain reference points

## A.1 Software Installation

The "ZN-Z8x User" tool can be installed on any PC running Windows 7 or higher. In the current version, Windows XP is also supported.

In addition to the requirements imposed by the operating system (e.g. see [Windows 7 system requirements](#)), you will need a spare USB port to establish a physical connection to the switch matrix.

Installation of the software is completely self-explanatory: run the `setup.exe` and follow the instructions of the installation wizard.

If not already available on the target PC, the wizard attempts to install the R&S ZN-Z USB BULK driver, which requires administrative privileges.

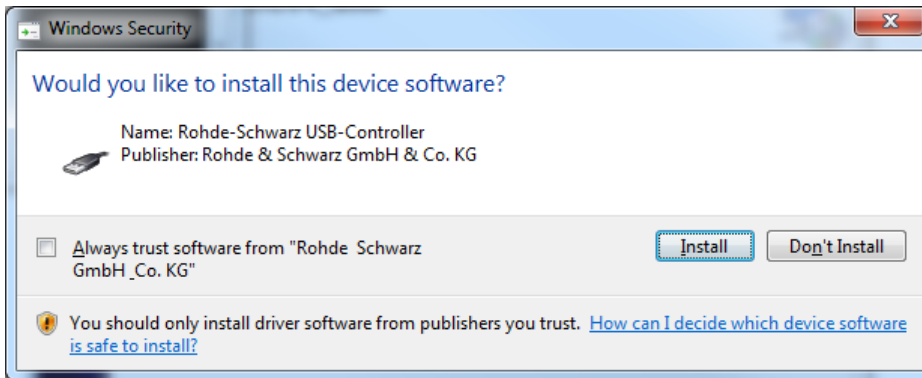
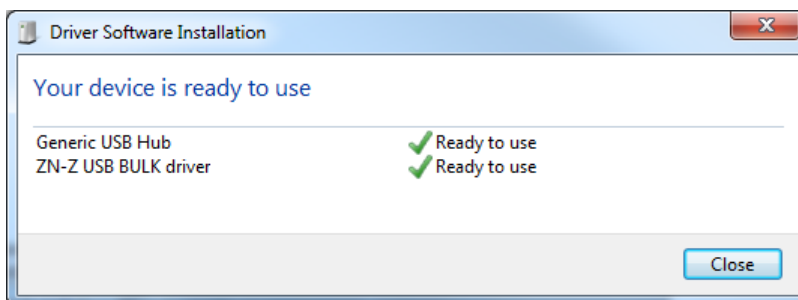

Fig. 1-1: USB device driver installation

## A.2 Getting Started

1. Start the R&S ZN-Z85 as described in [chapter 2.2.6, "Turning the Instrument On and Starting"](#), on page 17.
2. Connect the R&S ZN-Z85 via USB, as described in [chapter 2.3.1, "USB"](#), on page 18.

When first connected to a particular USB port, the R&S ZN-Z85 is auto-detected by the operating system:



Note that the "Generic USB Hub" is only installed if the switch matrix is connected via its front USB port (see [chapter 2.1.1.6, "USB Connector"](#), on page 10).

3. Select "All Programs > Rohde-Schwarz > ZN-Z8x > ZN-Z8x User" from the Windows Start menu.



**Tip:** On an R&S ZNx the ZN-Z8x User tool integrates into the "External Tools" softtool of the Vector Network Analyzer GUI (APPLIC hardkey or "System > External Tools" menu).

## Result

The "ZN-Z8x User" tool is started, and automatically connects to the detected switch matrix.



## A.3 Device Panel

The panel above the tabs allows to select one of the available R&S ZN-Z8x and displays the basic properties of the selected device (extension type, serial number, firmware version)



After matrices have been connected or disconnected, the list of available devices must be updated manually using the "Rescan" button.



## ROHDE & SCHWARZ

ZN-Z85-24, Serial: 100055, Version: 02.00

Installed Options: Basic/B24

- connected -

USB Devices available:

### Identification String

The line of text below the colored Rohde&Schwarz logo identifies a connected R&S ZN-Z85 by the following string:

ZN-Z85-<last two digits of highest option>, Serial: <serial number>, Version: <FW version>

Remote command:

\*IDN?

### Installed Options

This line of text lists the options that are installed on a connected R&S ZN-Z85.

Remote command:

\*OPT? on page 38

### USB Devices available / Rescan

Allows to select one of the detected switch matrices.

USB Devices available:

Use the "Rescan" button to refresh the list of detected switch matrices and to retrieve their properties.

## A.4 Test Tab

The Test tab allows to set up and delete matrix routes, to send SCPI commands to the switch matrix and to receive the command responses (if any).

The picture at the top of the tab visualizes the installed options: unequipped ports are greyed out and inactive.



Selecting a matrix in the [Device Panel](#) automatically deletes the currently switched routes.

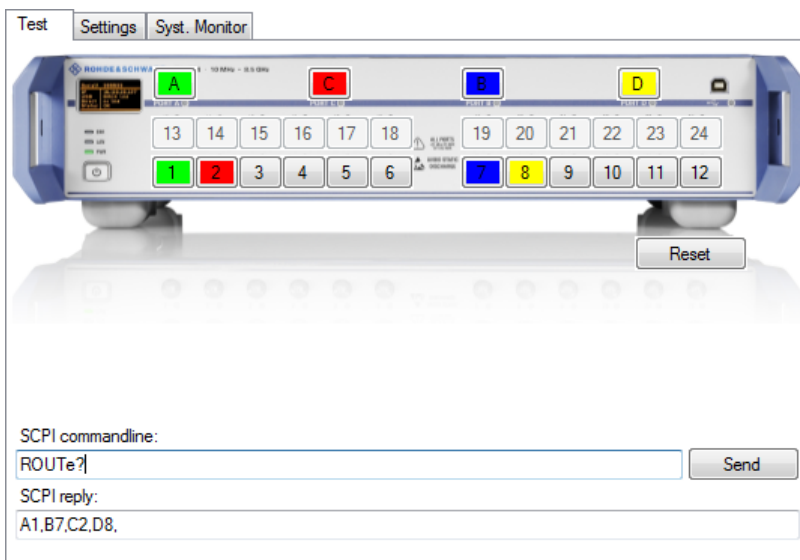

## Routes / Reset

Using the buttons overlaying the RF ports on the picture you can manually create and delete matrix routes. Existing routes are indicated in colors (see "[Color VNA Port A|B|C|D](#)" on page 53).

To create a route, first select one of the active VNA ports (A to D) and then one of the active test ports (1 to 12).

To delete a route, simply deselect (click) the corresponding test port or reuse one of its constituent ports in another route.

"Reset" deletes all existing routes.

Remote command:

`ROUTe`

`SHOW:ROUTes?`

## A.5 Settings Tab

The "Settings" tab allows to modify the LAN settings and the brightness and color of the RF port LEDs.

Test Settings **Syst. Monitor**

**LAN Settings:**

IP Setting

DHCP  
 Fixed IP

IP Address: 0.0.0.0  
Subnet Mask: 255.255.255.0  
Standard Gateway: 192.168.1.1  
Hostname: ZNZ85X100055

Apply LAN settings (nonpermanent)

**Port-LED Settings:**

Brightness:

Color VNA Port A:  Color VNA Port C:   
Color VNA Port B:  Color VNA Port D:

Restore Factory Defaults (nonpermanent) Write all settings to ZN-Z8x (permanent)

## IP Setting

Select "DHCP" if the R&S ZN-Z85 shall receive its IP configuration via DHCP or "Fixed IP" if the IP configuration shall be assigned manually.

Use [Write all settings to ZN-Z85 \(permanent\)](#) to make the changes persistent.

Remote command:

```
SHOW:LAN:DHCP?
```

```
SET:LAN:DHCP:ON
```

```
SET:LAN:DHCP:OFF
```

## IP address / Subnet Mask / Standard Gateway

Manual IP configuration (for "Fixed" [IP Setting](#)).

Use [Write all settings to ZN-Z85 \(permanent\)](#) to make the changes persistent.

Remote command:

```
SHOW:LAN:IP?
```

```
SET:LAN:IP
```

```
SHOW:LAN:SNMask?
```

```
SET:LAN:SNMask
```

```
SHOW:LAN:GW?
```

```
SET:LAN:GW
```

## Hostname

Gets/sets the R&S ZN-Z85's hostname (20 characters).

Remote command:

`SHOW:LAN:HOST:NAME?`

`SET:LAN:HOST:NAME`

## Apply LAN Settings (nonpermanent)

Activates the (modified) LAN settings on the matrix.

Use the [Write all settings to ZN-Z85 \(permanent\)](#) function to make the changes persistent.

Remote command:

`SET:LAN:INIT` on page 42

## Brightness

Move the slider to modify the brightness of the RF port LEDs.

Use [Write all settings to ZN-Z85 \(permanent\)](#) to make the changes persistent.

## Color VNA Port A|B|C|D

Allows to set the colors for the available VNA ports.

If a route between a VNA port  $V$  and a test port  $T$  exists,  $T$  will be highlighted with  $V$ 's color.

Use [Write all settings to ZN-Z85 \(permanent\)](#) to make the color changes persistent.

## Restore Factory Defaults (nonpermanent)

Restores the LAN and LED settings to their default values and activates them.

Use [Write all settings to ZN-Z85 \(permanent\)](#) to make the changes persistent.

## Write all settings to ZN-Z85 (permanent)

Writes the current settings (LAN, RF port LEDs), to the matrix flash. These settings are loaded during instrument startup.

Remote command:

`WRITE:MXINI`

## A.6 System Monitor Tab

The "System Monitor" tab displays temperatures and voltages at certain reference points. In case of instrument malfunction provide by the requested values to the Rohde&Schwarz service.

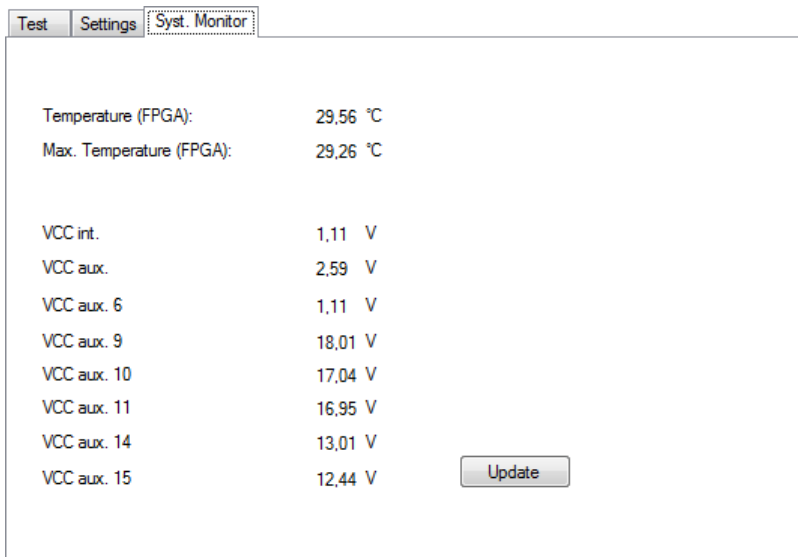

Test		Settings		Syst. Monitor	
Temperature (FPGA):	29,56	°C			
Max. Temperature (FPGA):	29,26	°C			
VCC int.	1,11	V			
VCC aux.	2,59	V			
VCC aux. 6	1,11	V			
VCC aux. 9	18,01	V			
VCC aux. 10	17,04	V			
VCC aux. 11	16,95	V			
VCC aux. 14	13,01	V			
VCC aux. 15	12,44	V			

Update

Use the "Update" button to retrieve the latest monitoring results from the selected R&S ZN-Z85.

## List of Commands

*IDN?.....	38
*OPT?.....	38
*RST.....	36
*SERial?.....	39
HANDshake:OFF.....	35
HANDshake:ON.....	35
HANDshake?.....	35
ROUTE.....	42
SET:LAN:DHCP:OFF.....	40
SET:LAN:DHCP:ON.....	40
SET:LAN:GW.....	41
SET:LAN:HOST:NAME.....	40
SET:LAN:INIT.....	42
SET:LAN:IP.....	41
SET:LAN:SNMask.....	41
SHOW:DIRectcon:STATus?.....	43
SHOW:LAN:DHCP?.....	40
SHOW:LAN:GW?.....	41
SHOW:LAN:HOST:NAME?.....	40
SHOW:LAN:IP?.....	41
SHOW:LAN:MAC:ADDRes?.....	40
SHOW:LAN:SNMask?.....	41
SHOW:ROUTes?.....	43
SYSTem:CLEar.....	36
SYSTem:ERRor?.....	36
WRITE:MXINI.....	44

# Index

## Symbols

*IDN .....	38
*OPT .....	38
*RST .....	36
*SERial .....	39

## D

DHCP Networks .....	19
Direct Control .....	10
Remote control interface .....	31
Status .....	43

## E

Errors .....	36
Clear .....	36

## F

Firmware	
Version .....	38
Front panel .....	7
Functional Check .....	18

## H

Handshake .....	35
-----------------	----

## I

Instrument Settings	
Reset .....	36

## L

LAN .....	10
Remote control interface .....	31
LAN settings	
Default Gateway .....	41
DHCP .....	40
Hostname .....	40
IP address .....	41
MAC address .....	40
Subnet mask .....	41
LAN Settings	
Apply .....	42
Default Gateway .....	41

## M

Matrix test ports .....	9
Matrix VNA ports .....	9

Micro SD .....	10
Mini display .....	8

## O

Option	
highest .....	38
List .....	38

## P

Power	
connector .....	10
switch .....	10
ProgBus .....	10

## R

Remote Control	
Interfaces .....	31
LAN Interface .....	34
Protocols .....	31
USB Interface .....	33
Reset	
Instrument Settings .....	36
Route .....	42

## S

Serial number .....	38, 39
Standby key .....	9
Status LEDs .....	8

## U

USB	
front panel .....	10
rear panel .....	10
Remote control interface .....	31
User settings	
Save .....	44